



شركة محمد عبدالله العريض المحدودة  
Mohammad Abdullah Al Areedh Ltd. Co.

# STC1000C

STC1000C TRUCK CRANE  
100 TONS LIFTING CAPACITY

Quality Changes the World

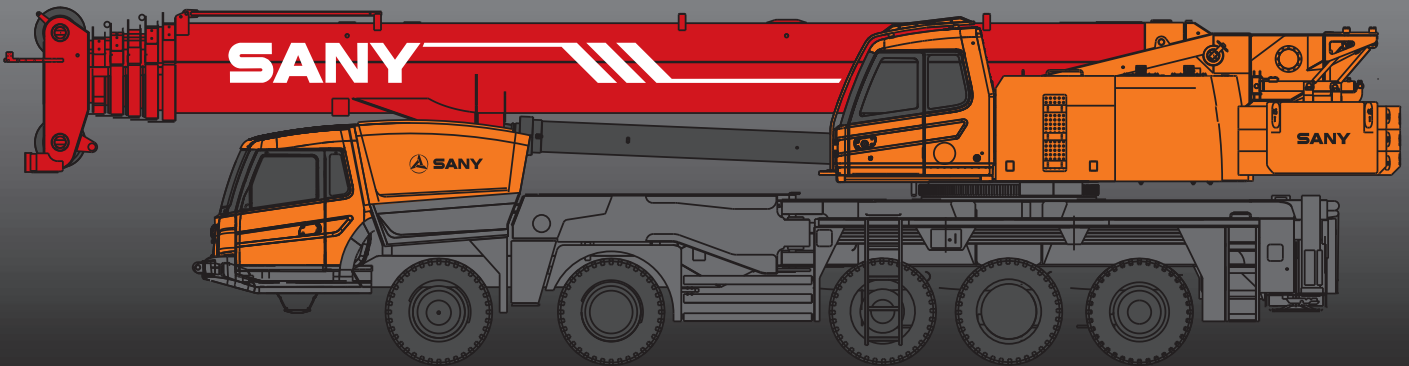

# SANY



SANY Automobile Hoisting Machinery is one of the core business unit of Sany Heavy Industry, mainly engaged in the research and development of high end, mid to large tonnage crane series, including mobile crane, crawler crane, tower crane and loader crane. It has two industrial parks in Ningxiang and Huzhou, since entering the market, the products of Sany Automobile Hoisting Machinery have received worldwide recognition with advanced technology, lean manufacturing, high reliability and excellent service.





# SANY TRUCK CRANE

## CONTENT

- 04 Icon
- 05 Selling points
- 06 Introduction
- 09 Dimension
- 10 Technical Parameter
- 11 Operation Condition
- 12 Load Chart
- 42 Counterweight sketch Map
- 43 Wheel Crane Family Map

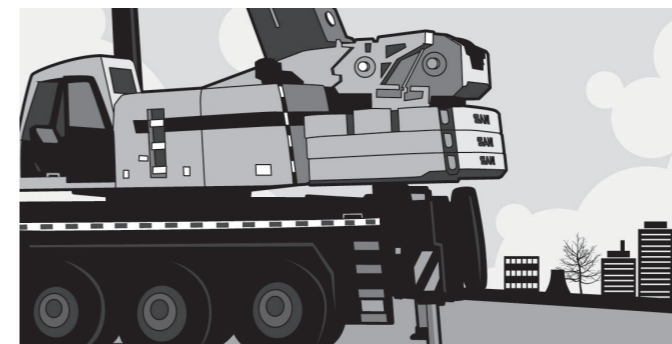
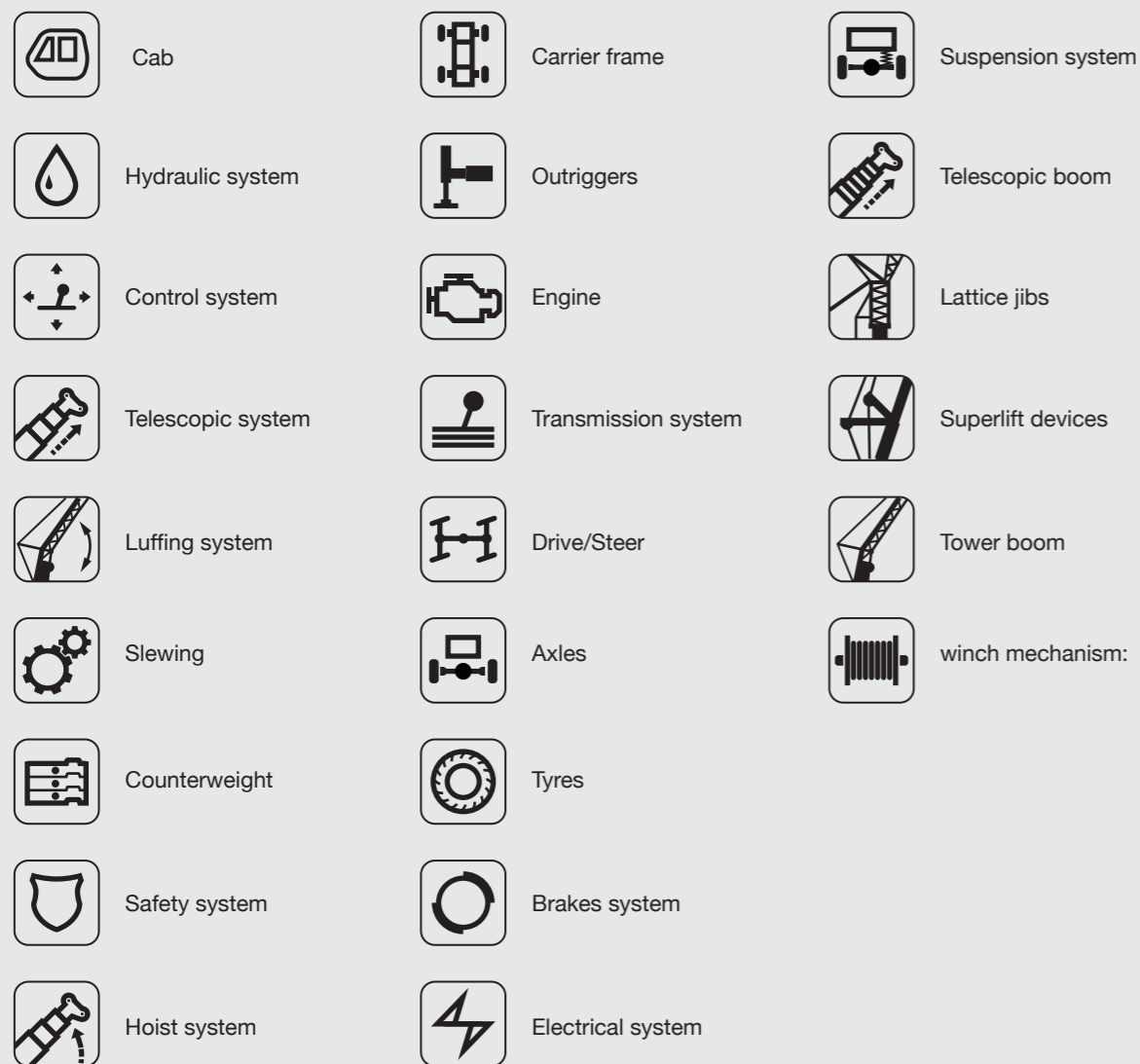

### Creative counterweight pushing technology

With full-counterweight weight of 32.5T, when counterweight is pushed backwards for 860mm, stability of the boom can be improved by up to 24%, thus improving lifting capacity and stability.



### Highly efficient and innovative chassis performance / chassis system

The use of innovative 5-axle chassis design and multi braking modes provide more reliable traveling performance for chassis. With tipping over early-warning technology, high stable overall operation and high safety can be achieved.



### Safe and stable lifting performance / boom system

Six-section boom of high strength steel structure and optimized U-shaped section reduces weight significantly and improve safety rates. Jib mounting angles are 0°, 15° and 30°, which ensures fast and convenient change-over between different operating conditions so as to improving working efficiency of the machine.



### Highly efficient, energy-saving and unique hydraulic control technology

Self-developed dual-pump converging / diversion main valve is used. Converging flow of the single-action dual-pump ensures fast operation and high work efficiency, combined-action dual-pump diversion system is applied to ensure stable controllability. Electric proportional variable displacement piston pump is used to ensure high-accurate flow control and higher efficiency and energy saving.



### Safe, stable, advanced and intelligent electronic control technology / electronic control system

Self-developed controller SYMC specially made for engineering machinery is adopted. The adoption of CAN-bus full-digital network control technology ensures stable control signal, simple harness and high reliability. Timely feedback of data information can achieve the monitoring of the overall working status in real-time. The load moment limiter equipped with the comprehensive intelligent protection system is used with accuracy within 5% to provide a comprehensive logic and interlock control, thus ensuring more safe and reliable operation.

## Superstructure



## Cab

- The self-made cab adopts ergonomic design with sliding door, safety glass, anti-corrosion steel, soft interior decoration, large interior space, panoramic sunroof and adjustable seats, air conditioner and electric window wiper etc., providing easier and more comfortable operation. Load moment limiter display is configured to achieve the combination of main console and operating display system, making all operating condition data of lifting operation clear at a glance.



## Hydraulic system

- Through the adoption of electric proportional variable displacement piston pump, pump displacement can be adjusted in real-time, achieving high-precision flow control with no energy loss during operation.
- Self-developed dual-pump converging / diversion main valve is used, enabling stable and convenient control of single action and combined action under different operation conditions.
- Main winch adopts electric proportional variable motor to ensure high operation efficiency. Max. single line speeds of main winch is up to 135m/min and the auxiliary winch is 123m/min.
- Closed slewing system with free slipping function equipped to ensure more stable starting and control of the slewing operation as well as excellent micro-mobility.



## Control system

- CAN-bus instrument: CAN-bus instrument with a combined intelligent control electrical system is used for easy reading of the traveling parameters at any time. The engine fault warning function is applied to ensure convenient and fast troubleshooting.
- Automatic outrigger system: Electrically controlled outrigger with automatic leveling, which is easy to operate.
- With fully security protection system, main and auxiliary winches are equipped with over-roll out limiter and height limiters to prevent over-rolling out and over-hoisting of steel rope, achieving limit angle protection.
- Load moment limiter: The adoption of high intelligent load moment limiter system can comprehensively protect lifting operation, ensuring accurate, stable and comfort operation.
- The fault diagnosis system can detect superstructure electricity and hydraulic as well as undercarriage chassis and gearbox for fault to ensure reliable operation of the crane.



## Luffing system

- The use of dead-weight luffing system with compensation control of the system ensures good luffing speed controllability, micro-mobility and excellent stability.
- Luffing angle :  $-2^{\circ} \sim 82^{\circ}$ .



## Telescopic system

- With single-cylinder pin technology, inserting and pulling actions of the cylinder pin and boom pin can be achieved through electrohydraulic control system.
- Telescopic action of the lifting boom can be applied with a single telescopic cylinder. The use of multi-stage pressure control, multiple telescopic balance valve element and mechanical hydraulic double-interlock mechanism of the cylinder pin and boom pin ensure safe and reliable operation of the telescopic system.
- Six-section boom is applied with basic boom length of 13.25m, full-extended boom length of 60m, jib length of 18.1m and fully extended boom lifting height of 60m respectively. Max. lifting height is 78.1m including jib. It is made of fine grain high-strength steel with U-shaped cross-section .



## Slewing system

- With  $360^{\circ}$  rotation and with Max slewing speed of  $2r/min$  applied. The use of electric proportional closed double slewing system ensures perfect operation and stable slewing.

## Superstructure



## Hoisting system

- The adoption of pump and motor double variable speed control ensures high efficiency and excellent energy saving functionality. With perfect combination of winch balance valve and unique anti-slip technology, heavy load can be lifted and lowered smoothly. Closed winch brake and winch balance valve effectively prevent imbalance of the hook.
- One 100t hook, one 50t hook and one 7t hook are configured with weight of 1180kg, 514kg and 250kg respectively. Wire rope of main winch: right-handed wire rope 35W×7- $\Phi$ 22-2160UZZ 280m. Wire rope of auxiliary winch: right-handed wire rope 35W×7- $\Phi$ 22-2160UZZ 190m.



## Safety system

- Load moment limiter: Load detection is achieved through the establishment of accurate and concise load model, which significantly increases the overall system precision of load moment limiter. Online empty load marking effectively prevent inaccurate lifting caused by discrepancy in boom structure specification, increasing system accuracy to  $\pm 5\%$ .
- Hydraulic system is configured with the balance valve, overflow valve and two-way hydraulic lock etc. components, thus achieving stable and reliable operation of the hydraulic system.
- Main and auxiliary winches are equipped with over roll-out limiter to prevent over rolling-out of wire rope.
- Boom and jib ends are equipped with height limiters respectively to prevent over-hoisting of wire rope.
- Boom head is equipped with anemometer to detect whether the high-altitude wind speed is within the allowable range.
- Boom head is equipped with anemometer and press sensor to indicate the working condition of whole crane in real-time, giving an alarm and cutting off the dangerous action automatically.



## Counterweight

- 32.5t movable counterweight can be moved backward 860mm.
- There are five counterweight combinations, 0, 8.5, 16.5, 23.5 and 32.5t, which is easy to install.
- Rotary radius is 4635 mm, and 5495 mm after translation movement.

## Chassis



## Cab

- Cab is made of new steel structure self-developed by SANY, featuring excellent shock absorption and tightness, which is configured with swing-out doors at both sides, pneumatically suspended driver's seat and passenger's seat, adjustable steering wheel, large rearview mirror, comfortable driver's chair with a headrest, anti-fog fan, air conditioner, stereo radio and complete control instruments and meters, providing more comfortable, safe and humanized operation experience.



## Carrier frame

- Designed and manufactured by SANY, anti-torsion box structure is welded by fine-grain high-strength steel plate to provide lighter weight and strong load bearing capacity. With bending strength increased by 46.8% and with torsional strength increased by 68% compared with original concave structure.











## Axles

- Axles 3,4 and 5 are drive axles and axles 1,2 and 5 are steering axles, axle and wheel differentials are installed in axle 3,4 and wheel differential is installed in axle 5. The use of welding process for axle housing provides stronger load bearing capacity.



## Chassis

 <b>Engine</b>	<ul style="list-style-type: none"> <li>■ Type: V-type eight-cylinder, water cooled, supercharged and inter-cooling diesel engine</li> <li>■ Rated power: 350kw/1800r/min</li> <li>■ Environment-protection: Emission complies with EuroIII standard</li> <li>■ Capacity of fuel tank: 450L</li> </ul>
 <b>Transmission system</b>	<ul style="list-style-type: none"> <li>■ Gearbox: Manual / Automatic gearbox is adopted with 12 forward gears, 2 backward gears and large speed ratio range applied, which meets the requirements of low gradeability speed and high traveling speed.</li> <li>■ Transmission shaft: With optimized arrangement of the transmission shaft, the transmission is stable and reliable. For most optimized transmission, face-tooth coupling transmission shaft is used with large transmission torque.</li> </ul>
 <b>Brakes system</b>	<ul style="list-style-type: none"> <li>■ Brakes system includes traveling brake, parking brake, emergency brake and auxiliary brake.</li> <li>■ Traveling brake: All wheels use the air servo brakes and dual-circuit brake system and are equipped with drum brakes.</li> <li>■ Parking brake: Force driven by accumulator is applied on the third to fifth axle.</li> <li>■ For emergency brake, accumulator is used not only for cutting-off brake but also for emergency brake.</li> <li>■ Auxiliary brake consists of engine brake and exhaust brake. Engine is equipped with dual brake with brake safety ensured while travelling.</li> </ul>
 <b>Suspension system</b>	<ul style="list-style-type: none"> <li>■ All axles adopt the plate spring suspension systems with plate spring passed 100,000 fatigue tests and with optimization of performance parameters of the front and rear plate springs applied to ensure strength and also to provide comfort ridding.</li> </ul>
 <b>Steering system</b>	<ul style="list-style-type: none"> <li>■ Single-circuit hydraulic power steering system equipped with mechanical steering limit is used with emergency steering device driven by emergency pump applied.</li> </ul>
 <b>Drive/Steer</b>	<ul style="list-style-type: none"> <li>■ 10×6×6</li> </ul>
 <b>Outriggers</b>	<ul style="list-style-type: none"> <li>■ Made of fine-grain high-strength steel sheet, outriggers can be controlled through control panel with automatic leveling function. Front swing outriggers and rear telescopic outriggers are arranged. Four-point supporting ensures easy operation and strong stability with Max. span up to 7.6m×7.6m.</li> </ul>
 <b>Tyres</b>	<ul style="list-style-type: none"> <li>■ 14*12.00R24 20PR</li> </ul>
 <b>Electrical system</b>	<ul style="list-style-type: none"> <li>■ With 2*12V maintenance-free batteries, the crane power can be cut off manually via a mechanical master power switch. The use of CAN-bus control system can achieve information interaction between superstructure and undercarriage.</li> </ul>

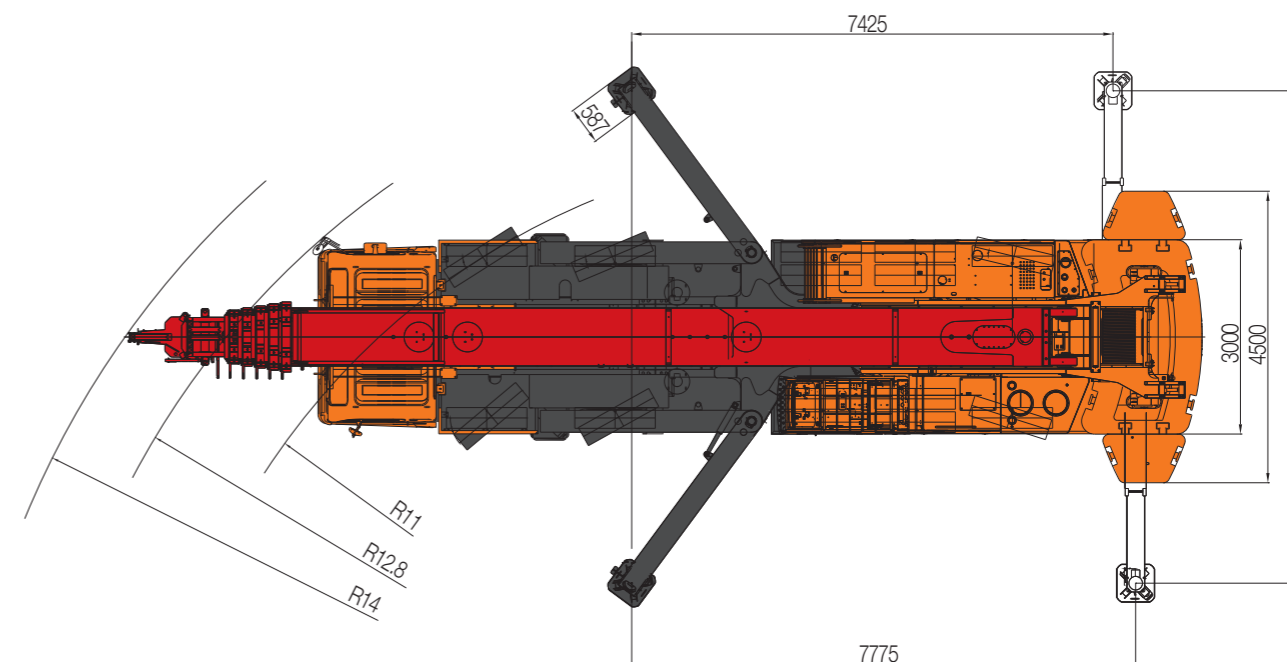
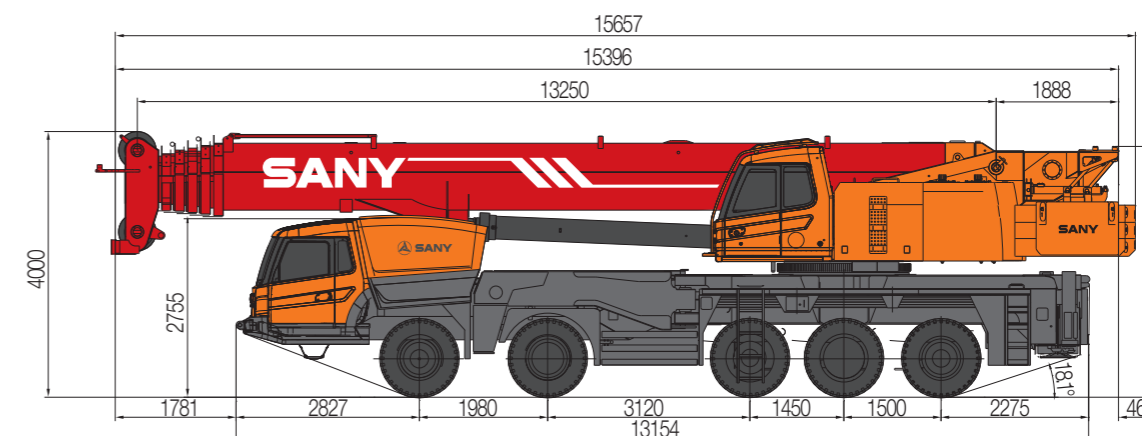



Type	Item	Parameter	
Capacity	Max. lifting capacity	100t	
Dimensions	Overall length	15396 mm	
	Overall width	3000 mm	
	Overall height	4000 mm	
	Axle distance	Axle-1,2: 1980 mm Axle-2,3: 3120 mm Axle-3,4: 1450 mm Axle-4,5: 1500 mm	
Weight	Overall weight	54950 kg	
	Axle load	Axle load-1,2: 9500/9500 kg Axle load-3,4: 12975/12975/10000 kg	
	Rated power	350 kW/ 180 rpm	
	Rated torque	2300 N.m/ 1080 rpm	
Traveling	Max.traveling speed	85 km/h	
	Turning radius	Min.turning radius	11 m
		Min.turning radius of boom head	14 m
	Wheel formula	10×6 ×6	
	Min.ground clearance	310 mm	
	Approach angle	21 °	
	Departure angle	18 °	
	Max.gradeability	45%	
Fuel consumption per 100km	≤ 70 L		
Main Performance Data	Temperature range	-2 °C ~ +82 °C	
	Min.rated range	3 m	
	Tail slewing radius of swingtable	4.59 m	
	Boom section	6	
	Boom shape	U-shaped	
	Max.lifting moment	Base boom	4320 kN·m
		Full-extend boom	1800 kN·m
		Full-extend boom+jib	kN·m
	Boom length	Base boom	13.25 m
		Full-extend boom	60 m
Full-extend boom+jib		78.1 m	
Outrigger span (Longitudinal×Transversal)	7.6 × 7.6 m		
Jib offset	0 °, 15 °, 30 °		
Working speed	Max.single rope lifting speed of main winch (no load)	135 m/min	
	Max.single rope lifting speed of auxiliary winch (no load)	123 m/min	
	Full extension/retraction time of boom	420 / 400 s	
	Full lifting/descending time of boom	80 / 90 s	
	Slewing speed	2 r/min	
Aircondition	Aircondition in up cab	Cooliomg/Heating	
	Aircondition in low cab	Cooliomg/Heating	

STC1000C Working Ranges

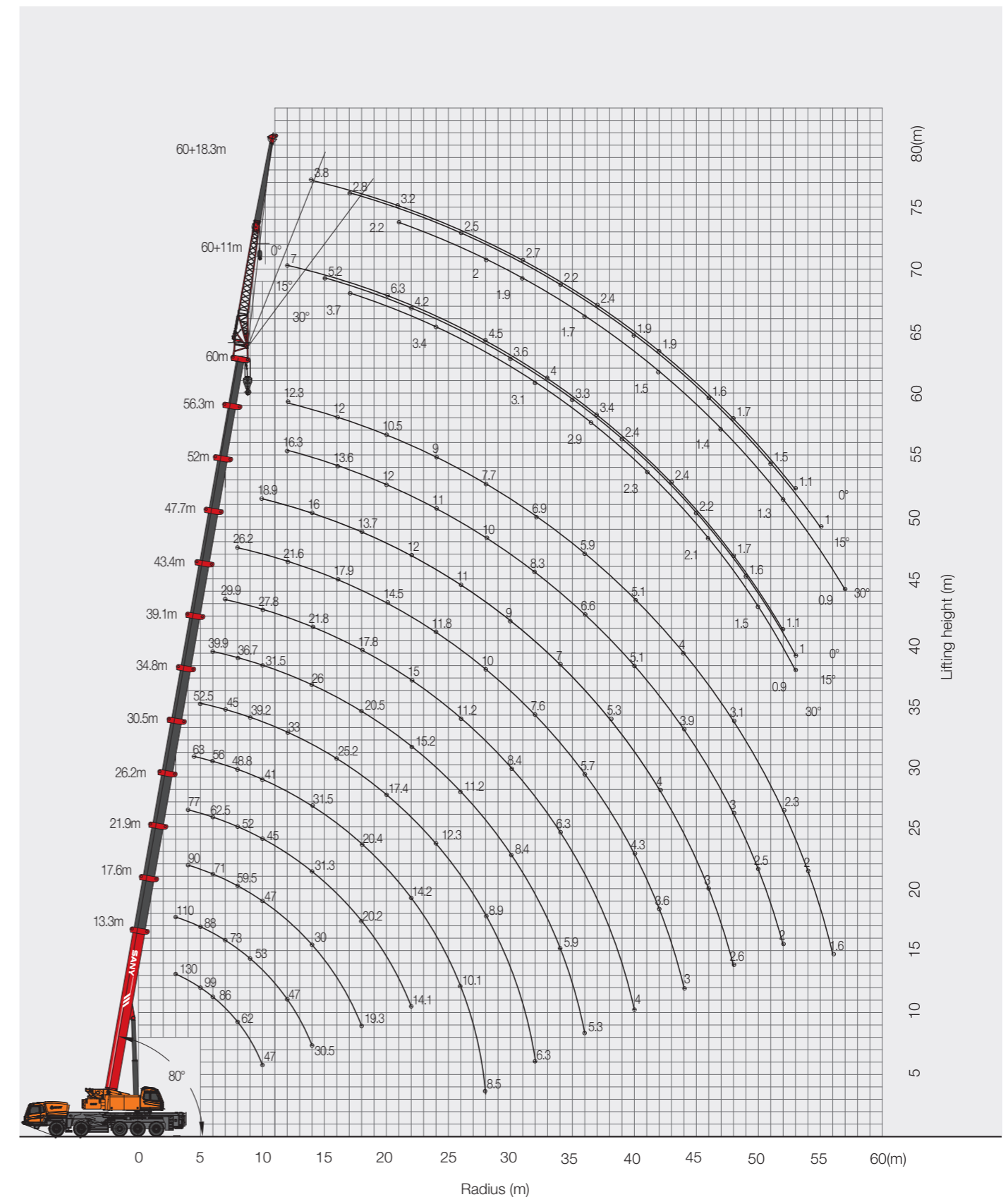



**Prerequisites:**

- ① Boom operating conditions(fully extended boom length),min.length is 13.25m and max.length is 60m
- ② The span of outriggers is 7.6m×7.6m
- ③ 360°rotation is applied
- ④ Counterweight is 32.5T

Range ( m )	Main boom															Range ( m )	
	13.25	17.5	17.5	17.5	21.8	21.8	21.8	26.1	26.1	26.1	30.5	30.5	30.5	34.8	34.8		
3	100	91	86	62												3	
3.5	100	87	86	62												3.5	
4	97	85	82	62	80.5	78.4	57.5	65	58	55.7						4	
4.5	89	81	74	60	74.7	74.4	54.7	64	56	52.2						4.5	
5	83	72.5	71	59	69	68	51.8	63	53.6	48.7	52	50.2	48.5	43.3	41.3	5	
5.5	77.5	69.75	68	58	65.5	64.5	49.2	61.5	50.75	46.1	50.8	47.1	46.4	41.1	39.4	5.5	
6	72	67	65	57	62	61	46.6	60	47.9	43.5	49.5	44	44.2	38.9	37.5	6	
6.5	65.5	63.5	62	56.5	58.5	58	44.4	58.7	45.75	41.4	48.3	41.7	42.1	36.75	35.65	6.5	
7	59	60	59	56	55	55	42.2	57.4	43.6	39.3	47.1	39.4	40	34.6	33.8	7	
8	53	51	50	50	50.6	50	39.1	51.7	40.2	35.7	42.6	35.3	36.2	31.1	30.9	8	
9	45	44	43	42	46	45.6	36.1	47	37.3	32.8	38.9	32	33.2	28.2	28.1	9	
10	39	38.5	38	37	38.2	37.6	33.5	43.5	34.2	30.3	35.4	29.5	30.6	25.4	25.9	10	
11		35.85	35	34	35.1	34.3	31.25	39	31.75	28.25	32.95	27.35	28.65	23.65	24.15	11	
12		33.2	32	31	32	31	29	34.5	29.3	26.2	30.5	25.2	26.7	21.9	22.4	12	
14		25.2	26.8	27.3	24	24	26.471	26.7	25.6	23.2	26.6	21.6	23.5	18.8	19.6	14	
16					20	20.9	23.793	21	21.6	20.5	21.8	19.1	20.9	16.4	17.4	16	
18					16.5	16.8	19.57	16.9	17.5	18.8	17.6	16.8	18.9	14.4	15.6	18	
20								13.8	14.4	16.1	14.5	13.8	16	12.6	13.5	20	
22								11.4	12	13.7	12.463	11.742	13.6	11.3	11.3	22	
24											10.506	9.785	11.7	9.7	9.6	24	
26											9.27	8.137	10.1	8.343	8.2	26	
28														7.004	7.1	28	
30														5.871	6.1	30	
32																32	
34																34	
36																36	
38																38	
40																40	
42																42	
44																44	
46																46	
48																48	
50																50	
52																52	
Number of lines	12	11	11	11	9	9	9	8	8	8	6	6	6	5	5	Number of lines	
Telescopic condition	II	0	46	0	0	46	0	0	46	92	0	46	92	0	92	46	Telescopic condition
	III	0	0	0	0	46	46	0	46	46	0	46	46	46	46	46	
	IV	0	0	46	0	0	46	0	46	0	46	46	46	46	46	46	
	V	0	0	0	46	0	0	46	0	0	46	46	0	46	46	46	
	VI	0	0	0	0	0	0	46	0	0	46	0	0	46	0	46	
	Hooks	110t hook(1815kg)										50t hook(580kg)					

**Prerequisites:**

- ① Boom operating conditions(fully extended boom length),min.length is 13.25m and max.length is 60m
- ② The span of outriggers is 7.6m×7.6m
- ③ 360°rotation is applied
- ④ Counterweight is 32.5T

Range ( m )	Main boom															Range ( m )
	34.8	39	39	39	43.3	43.3	43.3	47.6	47.6	47.6	52	52	56.2	60		
3																3
3.5																3.5
4																4
4.5																4.5
5	38.8															5
5.5	37.15															5.5
6	35.5	33.2	32.8	31.1												6
6.5	33.85	31.75	31.35	30												6.5
7	32.2	30.3	29.9	28.9	25	23.5	22.2									7
8	28.9	27.5	27	26.7	24	22.6	21	21.5	20.5	18.3						8
9	26.5	25	24.5	24.5	23.4	21.8	20.8	20.5	19.6	17.4	17.7	15.4				9
10	24.3	23.2	22.6	22.6	22.5	20.6	19.5	19	18.7	16.5	17	14.8	13.1	11.4		10
11	22.75	21.4	21	21.15	21.3	20.05	18.45	18.5		15.6	16.35	14.15	12.75	11.1		11
12	21.2	19.6	19.4	19.7	20.1	19.5	17.4	18	16.9	14.7	15.7	13.5	12.4	10.8		12
14	18.4	17.1	16.8	17.2	17.6	17.8	15.5	17	15.4	13.1	14.3	12.3	11.6	10.2		14
16	16.3	14.8	14.8	15.4	15.8	15.9	14	15.8	13.8	11.8	13.2	11.3	10.9	9.6		16
18	14.6	13.2	13.1	13.8	14.6	14.1	12.6	14.6	12.5	10.7	12	10.4	10.1	9		18
20	13	11.8	11.8	12.4	13.8	12.9	11.4	13.2	11.4	9.7	11.2	9.6	9.5	8.3		20
22	11.8	10.5	10.6	11.3	12.4	11.8	10.4	12.2	10.3	8.9	10.2	8.8	8.8	7.8		22
24	10.7	9.5	9.5	10.3	10.6	10.8	9.5	11.1	9.5	8.2	9.4	8.2	8.1	7.3		24
26	10	8.6	8.7	9.5	9.1	9.7	8.8	9.6	8.7	7.5	8.6	7.6	7.7	6.8		26
28	8.755	7.5	7.9	8.6	7.9	8.6	8.1	8.3	7.9	6.9	8	7.1	7.1	6.4		28
30	7.519	6.592	6.8	7.725	6.8	7.5	7.5	7.2	7.3	6.5	7.5	6.5	6.7	6		30
32		5.665	5.8	6.695	6	6.5	7.1	6.3	6.8	5.9	6.6	6	6.2	5.6		32
34		4.738	5	5.871	5.1	5.7	6.4	5.5	6	5.6	5.8	5.6	5.8	5.2		34
36					4.5	5	5.7	4.8	5.3	5.3	5.1	5.2	5.4	4.8		36
38								4.1	4.7	4.9	4.4	4.8	4.8	4.5		38
40								3.6	4.1	4.6	3.9	4.5	4.2	4.2		40
42											3.4	4	3.7	3.8		42
44											2.9	3.605	3.3	3.3		44
46												2.9	2.9			46
48													2.5	2.6		48
50														2.2		50
52														1.9		52
Number of lines	5	4	4	4	3	3	3	3	3	3	2	2	2	2	Number of lines	
Telescopic condition	II	0	92	46	46	92	46	46	92	46	46	92	46	92	100	Telescopic condition
	III	92	46	92	46	92	92	46	92	92	46	92	92	92	100	
	IV	46	46	46	46	46	92	46	92	92	92	92	92	92	100	
	V	46	46	46	46	46	46	92	46	92	92	92	92	92	100	
	VI	46	46	46	92	46	46	92	46	92	46	92	92	92	100	
	Hooks	50t hook(580kg)										Hooks				



**Prerequisites:**

- ① Boom operating conditions(fully extended boom length),min.length is 13.25m and max.length is 60m
- ② The span of outriggers is 7.6m×7.6m
- ③ 360°rotation is applied
- ④ Counterweight is 32.5T,counterweight cylinder extend 860mm

Range ( m )	Main boom															Range ( m )		
	13.25	17.5	17.5	17.5	21.8	21.8	21.8	26.1	26.1	26.1	30.5	30.5	30.5	34.8	34.8			
3	100	91	86	62												3		
3.5	100	87	86	62												3.5		
4	97	85	82	62	80.5	78.4	57.5	65	58	55.7						4		
4.5	89	81	74	60	74.7	74.4	54.7	64	56	52.2						4.5		
5	83	72.5	71	59	69	68	51.8	63	53.6	48.7	52	50.2	48.5	43.3	41.3	5		
5.5	77.5	69.75	68	58	65.5	64.5	49.2	61.5	50.75	46.1	50.8	47.1	46.4	41.1	39.4	5.5		
6	72	67	65	57	62	61	46.6	60	47.9	43.5	49.5	44	44.2	38.9	37.5	6		
6.5	65.5	63.5	62	56.5	58.5	58	44.4	58.7	45.75	41.4	48.3	41.7	42.1	36.75	35.65	6.5		
7	59	60	59	56	55	55	42.2	57.4	43.6	39.3	47.1	39.4	40	34.6	33.8	7		
8	53	51	50	50	50.6	50	39.1	51.7	40.2	35.7	42.6	35.3	36.2	31.1	30.9	8		
9	45	44	43	42	46	45.6	36.1	47	37.3	32.8	38.9	32	33.2	28.2	28.1	9		
10	42.31	41.81	38	37	38.2	37.6	33.5	43.5	34.2	30.3	35.4	29.5	30.6	25.4	25.9	10		
11		38.74	37.89	34	37.99	34.3	31.25	39	31.75	28.25	32.95	27.35	28.65	23.65	24.15	11		
12		35.76	34.56	31	34.56	31	29	34.5	29.3	26.2	30.5	25.2	26.7	21.9	22.4	12		
14		27.28	28.88	29.38	26.08	26.08	26.47	26.7	27.68	23.2	26.6	21.6	23.5	18.8	19.6	14		
16					21.75	22.65	23.79	22.75	23.35	20.5	21.8	19.1	20.9	16.4	17.4	16		
18					18.02	18.32	21.09	18.42	19.02	20.32	19.12	18.32	18.9	14.4	15.6	18		
20								15.13	15.73	17.43	15.83	15.13	17.33	12.6	13.5	20		
22								12.59	13.19	14.89	13.66	12.93	14.79	12.49	11.3	22		
24											11.58	10.86	12.78	10.78	9.6	24		
26											10.25	9.12	11.08	9.33	9.18	26		
28														7.91	8.00	28		
30														6.71	6.94	30		
32																32		
34																34		
36																36		
38																38		
40																40		
42																42		
44																44		
46																46		
48																48		
50																50		
52																52		
Number of lines	12	11	11	11	9	9	9	8	8	8	6	6	6	5	5	Number of lines		
Telescopic condition	II	0	46	0	0	46	0	0	46	92	0	46	92	0	92	46	II	Telescopic condition
	III	0	0	0	0	46	46	0	46	46	0	46	46	46	46	46	III	
	IV	0	0	46	0	0	46	0	46	0	46	46	46	46	46	46	IV	
	V	0	0	0	46	0	0	46	0	0	46	46	0	46	46	46	V	
	VI	0	0	0	0	0	0	46	0	0	46	0	0	46	0	46	VI	
	Hooks	110t hook(1815kg)										50t hook(580kg)					Hooks	

**Prerequisites:**

- ① Boom operating conditions(fully extended boom length),min.length is 13.25m and max.length is 60m
- ② The span of outriggers is 7.6m×7.6m
- ③ 360°rotation is applied
- ④ Counterweight is 32.5T,counterweight cylinder extend 860mm

Range ( m )	Main boom															Range ( m )	
	34.8	39	39	39	43.3	43.3	43.3	47.6	47.6	47.6	52	52	56.2	60			
3																3	
3.5																3.5	
4																4	
4.5																4.5	
5	38.8															5	
5.5	37.15															5.5	
6	35.5	33.2	32.8	31.1												6	
6.5	33.85	31.75	31.35	30												6.5	
7	32.2	30.3	29.9	28.9	25	23.5	22.2									7	
8	28.9	27.5	27	26.7	24	22.6	21	21.5	20.5	18.3						8	
9	26.5	25	24.5	24.5	23.4	21.8	20.8	20.5	19.6	17.4	17.7	15.4				9	
10	24.3	23.2	22.6	22.6	22.5	20.6	19.5	19	18.7	16.5	17	14.8	13.1	11.4		10	
11	22.75	21.4	21	21.15	21.3	20.05	18.45	18.5		15.6	16.35	14.15	12.75	11.1		11	
12	21.2	19.6	19.4	19.7	20.1	19.5	17.4	18	16.9	14.7	15.7	13.5	12.4	10.8		12	
14	18.4	17.1	16.8	17.2	17.6	17.8	15.5	17	15.4	13.1	14.3	12.3	11.6	10.2		14	
16	16.3	14.8	14.8	15.4	15.8	15.9	14	15.8	13.8	11.8	13.2	11.3	10.9	9.6		16	
18	14.6	13.2	13.1	13.8	14.6	14.1	12.6	14.6	12.5	10.7	12	10.4	10.1	9		18	
20	13	11.8	11.8	12.4	13.8	12.9	11.4	13.2	11.4	9.7	11.2	9.6	9.5	8.3		20	
22	12.99	10.5	10.6	11.3	12.4	11.8	10.4	12.2	10.3	8.9	10.2	8.8	8.8	7.8		22	
24	11.78	9.5	9.5	10.3	10.6	10.8	9.5	11.1	9.5	8.2	9.4	8.2	8.1	7.3		24	
26	10.98	9.58	8.7	9.5	9.1	10.68	8.8	9.6	8.7	7.5	8.6	7.6	7.7	6.8		26	
28	9.66	8.40	7.9	8.6	7.9	9.50	8.1	8.3	7.9	6.9	8	7.1	7.1	6.4		28	
30	8.35	7.42	7.64	7.725	7.64	8.34	8.34	8.04	7.3	6.5	7.5	6.5	6.7	6		30	
32		6.44	6.58	7.47	6.78	7.28	7.88	7.08	6.8	6.68	6.6	6	6.2	5.6		32	
34		5.47	5.73	6.60	5.83	6.43	7.13	6.23	6	6.33	5.8	5.6	5.8	5.2		34	
36					5.18	5.68	6.38	5.48	5.98	5.98	5.78	5.2	5.4	4.8		36	
38								4.74	5.34	5.54	5.04	4.8	4.8	4.5		38	
40								4.21	4.71	5.21	4.51	5.11	4.2	4.81		40	
42											3.98	4.58	4.28	4.38		42	
44											3.45	4.15	3.85	3.85		44	
46												3.42	3.42			46	
48												3.00	3.10			48	
50													2.68			50	
52													2.36			52	
Number of lines	5	4	4	4	3	3	3	3	3	3	2	2	2	2	Number of lines		
Telescopic condition	II	0	92	46	46	92	46	46	92	46	46	92	46	92	100	II	Telescopic condition
	III	92	46	92	46	92	92	46	92	92	46	92	92	92	100	III	
	IV	46	46	46	46	46	92	46	92	92	92	92	92	92	100	IV	
	V	46	46	46	46	46	46	92	46	92	92	92	92	92	100	V	
	VI	46	46	46	92	46	46	92	46	92	46	92	46	92	100	VI	
	Hooks	50t hook(580kg)										Hooks					

**Prerequisites:**

- ① Boom operating conditions(fully extended boom length),min. length is 13.25m and max.length is 60m
- ② The span of outriggers is 7.6m×5.3m
- ③ 360°rotation is applied
- ④ Counterweight is 0T

Range ( m )	Main boom														Range ( m )		
	13.25	17.60	17.60	17.60	21.90	21.90	21.90	26.00	26.00	26.00	30.50	30.50	30.50	34.80		34.80	
3.0	90.00	80	70.00	62.00												3.0	
3.5	80.00	70	70	62												3.5	
4.0	65.00	65	65	62.00	60	60	57.5	62	58	55.7						4.0	
4.5	47.71	37.47	39.20	39.87	38.00	39.39	41.61	38.88	37.72	41.89	38.51	39.89	39.00			4.5	
5.0	36.58	28.66	30.16	30.73	29.13	30.32	32.24	29.88	28.88	32.48	29.56	30.75	32.27	30.37	31.69	5.0	
6.0	28.00	18.82	20.05	20.53	19.21	20.19	21.76	19.83	19.01	21.96	19.57	20.54	21.79	20.22	21.31	6.0	
7.0	20.00	13.46	14.54	14.96	13.79	14.66	16.05	14.34	13.62	16.22	14.11	14.97	16.07	14.69	15.65	7.0	
8.0	15.00	10.07	11.07	11.45	10.39	11.18	12.45	10.89	10.22	12.61	10.68	11.46	12.47	11.21	12.09	8.0	
9.0	11.00	7.75	8.68	9.04	8.04	8.79	9.98	8.51	7.89	10.13	8.32	9.05	10.00	8.81	9.64	9.0	
10.0	9.00	6.05	6.94	7.28	6.33	7.04	8.18	6.78	6.19	8.32	6.59	7.29	8.19	7.07	7.85	10.0	
12.0		3.73	4.57	4.89	4.00	4.66	5.72	4.42	3.87	5.85	4.24	4.90	5.73	4.68	5.41	12.0	
14.0		1.85	2.52	2.77	2.07	2.60	3.44	2.40	1.97	3.54	2.27	2.78	3.45	2.62	3.19	14.0	
16.0					1.18	1.69	2.51	1.51	1.09	2.60	1.38	1.88	2.51	1.71	2.27	16.0	
18.0							1.82			1.91		1.20	1.82	1.04	1.59	18.0	
20.0										1.38			1.29		1.06	20.0	
22.0										1.55			1.34			22.0	
24.0																24.0	
26.0																26.0	
28.0																28.0	
30.0																30.0	
32.0																32.0	
34.0																34.0	
36.0																36.0	
38.0																38.0	
40.0																40.0	
42.0																42.0	
44.0																44.0	
46.0																46.0	
48.0																48.0	
50.0																50.0	
52.0																52.0	
54.0																54.0	
56.0																56.0	
Telescopic condition	II	0.00	46.00	0.00	0.00	46.00	0.00	0.00	46.00	92.00	0.00	46.00	92.00	0.00	92.00	46.00	II
	III	0.00	0.00	0.00	0.00	46.00	46.00	0.00	46.00	46.00	0.00	46.00	46.00	46.00	46.00	46.00	III
	IV	0.00	0.00	46.00	0.00	0.00	46.00	0.00	46.00	0.00	46.00	46.00	46.00	46.00	46.00	46.00	IV
	V	0.00	0.00	0.00	46.00	0.00	0.00	46.00	0.00	0.00	46.00	46.00	0.00	46.00	46.00	46.00	V
	VI	0.00	0.00	0.00	0.00	0.00	0.00	46.00	0.00	0.00	46.00	0.00	0.00	46.00	0.00	46.00	VI

**Prerequisites:**

- ① Boom operating conditions(fully extended boom length),min. length is 13.25m and max.length is 60m
- ② The span of outriggers is 7.6m×5.3m
- ③ 360°rotation is applied
- ④ Counterweight is 0T

Range ( m )	Main boom														Range ( m )	
	34.80	39.10	39.10	39.10	43.40	43.40	43.40	47.70	47.70	47.70	52.00	52.00	56.30	60.00		
3.0																3.0
3.5																3.5
4.0																4.0
4.5																4.5
5.0	32.11															5.0
6.0	21.66	20.95	21.25	21.92												6.0
7.0	15.95	15.33	15.60	16.18												7.0
8.0	12.36	11.79	12.04	12.57	11.77	12.17	12.81									8.0
9.0	9.90	9.36	9.59	10.09	9.34	9.72	10.31	9.48	9.95	10.36						9.0
10.0	8.10	7.58	7.80	8.28	7.57	7.92	8.49	7.70	8.15	8.54	7.92	8.45	8.22	8.26		10.0
12.0	5.64	5.17	5.37	5.82	5.15	5.48	6.01	5.28	5.69	6.06	5.48	5.97	5.76	5.79		12.0
14.0	3.38	3.00	3.16	3.51	2.99	3.25	3.67	3.08	3.41	3.70	3.25	3.64	3.47	3.49		14.0
16.0	2.45	2.08	2.24	2.58	2.07	2.32	2.73	2.16	2.48	2.76	2.32	2.70	2.53	2.56		16.0
18.0	1.76	1.40	1.55	1.89	1.39	1.64	2.03	1.48	1.79	2.06	1.64	2.00	1.84	1.87		18.0
20.0	1.23		1.03	1.35		1.11	1.49		1.26	1.53	1.11	1.46	1.31	1.33		20.0
22.0	1.24						1.07			1.10		1.04				22.0
24.0																24.0
26.0																26.0
28.0																28.0
30.0																30.0
32.0																32.0
34.0																34.0
36.0																36.0
38.0																38.0
40.0																40.0
42.0																42.0
44.0																44.0
46.0																46.0
48.0																48.0
50.0																50.0
52.0																52.0
54.0																54.0
56.0																56.0
Telescopic condition	II	0.00	92.00	46.00	46.00	92.00	46.00	46.00	92.00	46.00	46.00	92.00	46.00	92.00	100.00	II
	III	92.00	46.00	92.00	46.00	92.00	92.00	46.00	92.00	92.00	46.00	92.00	92.00	92.00	100.00	III
	IV	46.00	46.00	46.00	46.00	46.00	92.00	46.00	92.00	92.00	46.00	92.00	92.00	92.00	100.00	IV
	V	46.00	46.00	46.00	46.00	46.00	46.00	92.00	46.00	92.00	46.00	92.00	92.00	92.00	100.00	V
	VI	46.00	46.00	46.00	92.00	46.00	46.00	92.00	46.00	92.00	46.00	92.00	46.00	92.00	100.00	VI



**Prerequisites:**

- ① Boom operating conditions(fully extended boom length),min. length is 13.25m and max.length is 60m
- ② The span of outriggers is 7.6m×5.3m
- ③ 360°rotation is applied
- ④ Counterweight is 8.5T

Range ( m )	Main boom														Range ( m )		
	13.25	17.60	17.60	17.60	21.90	21.90	21.90	26.00	26.00	26.00	30.50	30.50	30.50	34.80		34.80	
3.0	90.00	80.00	70.00	62.00												3.0	
3.5	80.00	80.00	70.00	62.00												3.5	
4.0	70.00	70.00	70.00	62.00	60.00	60.00	57.50	60.00	58.00	55.70						4.0	
4.5	65.60	64.73	66.89	60.00	65.40	67.13	54.70	64.00	56.00	52.20	52.00	49.00	52.00			4.5	
5.0	50.75	50.00	51.86	52.58	50.58	52.07	51.80	51.52	50.27	48.70	51.00	48.50	50.20	43.00	41.30	5.0	
6.0	34.17	33.53	35.07	35.66	34.01	35.24	37.21	34.78	33.76	37.45	34.46	35.68	37.23	35.28	36.64	6.0	
7.0	25.04	24.55	25.90	26.43	24.97	26.06	27.79	25.65	24.75	28.01	25.37	26.44	27.81	26.09	27.29	7.0	
8.0	19.08	18.89	20.13	20.61	19.28	20.27	21.86	19.91	19.08	22.06	19.64	20.63	21.88	20.31	21.41	8.0	
9.0	15.20	15.00	16.17	16.62	15.36	16.30	17.79	15.95	15.18	17.97	15.71	16.63	17.81	16.33	17.36	9.0	
10.0	12.36	12.16	13.27	13.70	12.51	13.40	14.82	13.07	12.33	14.99	12.83	13.71	14.83	13.43	14.41	10.0	
12.0		8.28	9.32	9.73	8.62	9.44	10.77	9.14	8.45	10.93	8.92	9.74	10.78	9.47	10.38	12.0	
14.0		5.76	6.76	7.14	6.09	6.88	8.14	6.59	5.93	8.29	6.38	7.16	8.15	6.91	7.77	14.0	
16.0					4.31	5.08	6.30	4.80	4.17	6.44	4.60	5.35	6.31	5.11	5.94	16.0	
18.0					3.00	3.74	4.94	3.47	2.86	5.08	3.28	4.01	4.94	3.77	4.59	18.0	
20.0								2.45	1.85	4.02	2.26	2.98	3.89	2.75	3.54	20.0	
22.0								1.64	1.04	3.19	1.46	2.16	3.06	1.93	2.72	22.0	
24.0														1.27	2.04	24.0	
26.0															1.48	26.0	
28.0																28.0	
30.0																30.0	
32.0																32.0	
34.0																34.0	
36.0																36.0	
38.0																38.0	
40.0																40.0	
42.0																42.0	
44.0																44.0	
46.0																46.0	
48.0																48.0	
50.0																50.0	
52.0																52.0	
54.0																54.0	
56.0																56.0	
Telescopic condition	II	0.00	46.00	0.00	0.00	46.00	0.00	0.00	46.00	92.00	0.00	46.00	0.00	92.00	92.00	46.00	II
	III	0.00	0.00	0.00	0.00	46.00	46.00	0.00	46.00	46.00	0.00	46.00	46.00	46.00	46.00	46.00	III
	IV	0.00	0.00	46.00	0.00	0.00	46.00	0.00	46.00	0.00	46.00	46.00	46.00	46.00	46.00	46.00	IV
	V	0.00	0.00	0.00	46.00	0.00	0.00	46.00	0.00	0.00	46.00	46.00	46.00	0.00	46.00	46.00	V
	VI	0.00	0.00	0.00	0.00	0.00	0.00	46.00	0.00	0.00	46.00	0.00	46.00	0.00	0.00	46.00	VI

**Prerequisites:**

- ① Boom operating conditions(fully extended boom length),min. length is 13.25m and max.length is 60m
- ② The span of outriggers is 7.6m×5.3m
- ③ 360°rotation is applied
- ④ Counterweight is 8.5T

Range ( m )	Main boom														Range ( m )	
	34.80	39.10	39.10	39.10	43.40	43.40	43.40	47.70	47.70	47.70	52.00	52.00	56.30	60.00		
3.0																3.0
3.5																3.5
4.0																4.0
4.5																4.5
5.0	38.80															5.0
6.0	35.50	33.20	32.80	31.10												6.0
7.0	27.67	26.89	27.22	27.96	25.00	23.50	22.20									7.0
8.0	21.75	21.04	21.34	22.01	21.01	21.51	21.00	21.20	20.50	18.30						8.0
9.0	17.68	17.01	17.30	17.93	16.99	17.46	18.20	17.16	17.75	17.40	17.70	15.4				9.0
10.0	14.71	14.08	14.35	14.95	14.06	14.50	15.21	14.22	14.78	15.27	14.50	14.8	13.10	11.40		10.0
12.0	10.67	10.08	10.33	10.89	10.06	10.47	11.13	10.21	10.73	11.19	10.47	11.08	10.81	10.80		12.0
14.0	8.05	7.48	7.72	8.25	7.46	7.86	8.48	7.61	8.10	8.54	7.86	8.44	8.18	8.22		14.0
16.0	6.21	5.66	5.89	6.40	5.64	6.02	6.63	5.78	6.26	6.68	6.02	6.58	6.34	6.38		16.0
18.0	4.84	4.31	4.54	5.04	4.30	4.67	5.25	4.43	4.90	5.30	4.66	5.21	4.97	5.01		18.0
20.0	3.79	3.27	3.50	3.98	3.26	3.62	4.20	3.39	3.85	4.24	3.62	4.15	3.92	3.95		20.0
22.0	2.96	2.45	2.67	3.15	2.44	2.79	3.36	2.57	3.01	3.40	2.79	3.31	3.08	3.12		22.0
24.0	2.28	1.78	2.00	2.47	1.77	2.11	2.67	1.89	2.33	2.72	2.11	2.63	2.40	2.44		24.0
26.0	1.72			1.90	1.21	1.56	2.11	1.34	1.77	2.15	1.55	2.06	1.84	1.87		26.0
28.0				1.43			1.63		1.30	1.67	1.08	1.58	1.36	1.40		28.0
30.0												1.18				30.0
32.0																32.0
34.0																34.0
36.0																36.0
38.0																38.0
40.0																40.0
42.0																42.0
44.0																44.0
46.0																46.0
48.0																48.0
50.0																50.0
52.0																52.0
54.0																54.0
56.0																56.0
Telescopic condition	II	0.00	92.00	46.00	46.00	92.00	46.00	46.00	92.00	46.00	46.00	92.00	46.00	92.00	100.00	II
	III	92.00	46.00	92.00	46.00	92.00	92.00	46.00	92.00	92.00	46.00	92.00	92.00	92.00	100.00	III
	IV	46.00	46.00	46.00	46.00	46.00	92.00	46.00	92.00	92.00	92.00	92.00	92.00	92.00	100.00	IV
	V	46.00	46.00	46.00	46.00	46.00	46.00	92.00	46.00	92.00	92.00	92.00	92.00	92.00	100.00	V
	VI	46.00	46.00	46.00	92.00	46.00	46.00	92.00	46.00	92.00	46.00	92.00	92.00	92.00	100.00	VI

**Prerequisites:**  
 ① Boom operating conditions(fully extended boom length),min.length is 13.25m and max.length is 60m  
 ② The span of outriggers is 7.6m×5.3m  
 ③ 360°rotation is applied  
 ④ Counterweight is 16.5T

Range ( m )	Main boom															Range ( m )	
	13.25	17.60	17.60	17.60	21.90	21.90	21.90	26.00	26.00	26.00	30.50	30.50	30.50	34.80	34.80		
3.0	90.00	90.00	80.00	80.00												3.0	
3.5	80.00	80.00	80.00	80.00												3.5	
4.0	70.00	70.00	70.00	70.00	60.00	60.00	57.50	65.00	58.00	55.70						4.0	
4.5	65.60	64.73	66.89	60.00	65.40	67.13	54.70	64.00	56.00	52.20	53.00	52.00	49.00			4.5	
5.0	64.08	63.33	65.20	65.92	63.91	65.41	51.80	63.00	53.60	48.70	52.00	50.20	48.50	43.30	41.30	5.0	
6.0	43.58	42.94	44.48	45.07	43.42	44.65	46.60	44.19	43.17	43.50	43.87	44.00	44.20	38.90	37.50	6.0	
7.0	32.32	31.82	33.18	33.70	32.24	33.33	35.06	32.93	32.02	35.28	32.64	33.71	35.09	33.36	33.80	7.0	
8.0	25.01	24.81	26.06	26.54	25.20	26.20	27.79	25.83	25.00	27.99	25.57	26.55	27.81	26.23	27.33	8.0	
9.0	20.20	20.00	21.17	21.62	20.36	21.30	22.79	20.95	20.18	22.97	20.71	21.63	22.81	33.71	35.09	9.0	
10.0	16.68	16.48	17.59	18.02	16.83	17.72	19.14	17.39	16.65	19.31	17.16	18.04	19.16	33.71	35.09	10.0	
12.0		11.69	12.73	13.13	12.02	12.85	14.17	12.54	11.86	14.33	12.33	13.14	14.19	33.71	35.09	12.0	
14.0		8.57	9.57	9.95	8.90	9.69	10.95	9.40	8.74	11.10	9.19	9.97	10.96	33.71	35.09	14.0	
16.0					6.70	7.47	8.69	7.19	6.55	8.83	6.99	7.74	8.70	33.71	35.09	16.0	
18.0					5.07	5.82	7.01	5.55	4.93	7.15	5.36	6.09	7.02	33.71	35.09	18.0	
20.0								4.29	3.69	5.86	4.10	4.82	5.73	33.71	35.09	20.0	
22.0								3.29	2.69	4.84	3.11	3.81	4.71	33.71	35.09	22.0	
24.0											2.29	2.99	3.88	33.71	35.09	24.0	
26.0											1.62	2.31	3.19	33.71	35.09	26.0	
28.0														33.71	35.09	28.0	
30.0														33.71	35.09	30.0	
32.0																32.0	
34.0																34.0	
36.0																36.0	
38.0																38.0	
40.0																40.0	
42.0																42.0	
44.0																44.0	
46.0																46.0	
48.0																48.0	
50.0																50.0	
52.0																52.0	
54.0																54.0	
56.0																56.0	
Telescopic condition	II	0.00	46.00	0.00	0.00	46.00	0.00	0.00	46.00	0.00	0.00	46.00	92.00	0.00	92.00	46.00	II
	III	0.00	0.00	0.00	0.00	46.00	46.00	0.00	46.00	92.00	0.00	46.00	46.00	46.00	46.00	46.00	III
	IV	0.00	0.00	46.00	0.00	0.00	46.00	0.00	46.00	46.00	46.00	46.00	46.00	46.00	46.00	46.00	IV
	V	0.00	0.00	0.00	46.00	0.00	0.00	46.00	0.00	0.00	46.00	46.00	0.00	46.00	46.00	46.00	V
	VI	0.00	0.00	0.00	0.00	0.00	0.00	46.00	0.00	0.00	46.00	0.00	0.00	46.00	0.00	46.00	VI

**Prerequisites:**  
 ① Boom operating conditions(fully extended boom length),min.length is 13.25m and max.length is 60m  
 ② The span of outriggers is 7.6m×5.3m  
 ③ 360°rotation is applied  
 ④ Counterweight is 16.5T

Range ( m )	Main boom															Range ( m )
	34.80	39.10	39.10	39.10	43.40	43.40	43.40	47.70	47.70	47.70	52.00	52.00	56.30	60.00		
3.0																3.0
3.5																3.5
4.0																4.0
4.5																4.5
5.0	38.80															5.0
6.0	35.50	33.20	32.80	31.10												6.0
7.0	32.20	30.30	29.90	28.90	25.00	23.50	22.20									7.0
8.0	27.68	26.96	27.27	27.94	24.00	22.60	21.00	21.50	20.50	18.30						8.0
9.0	22.68	22.01	22.30	22.93	21.99	22.46	20.80	20.50	19.60	17.40	17.70	15.40				9.0
10.0	19.04	18.40	18.67	19.27	18.38	18.82	19.50	19.00	18.70	16.50	17.00	14.80	13.10	11.40		10.0
12.0	14.08	13.48	13.74	14.29	13.46	13.88	14.54	16.07	16.90	14.59	13.88	13.50	12.40	10.80		12.0
14.0	10.85	10.29	10.53	11.06	10.27	10.66	11.29	12.15	12.88	11.34	10.66	12.30	10.99	10.20		14.0
16.0	8.59	8.05	8.28	8.79	8.03	8.41	9.02	9.48	10.09	9.07	8.41	11.30	8.72	8.76		16.0
18.0	6.92	6.39	6.62	7.11	6.37	6.74	7.33	7.52	8.14	7.38	6.74	7.29	7.05	7.09		18.0
20.0	5.63	5.11	5.34	5.82	5.10	5.46	6.03	5.97	6.59	6.08	5.46	5.99	5.76	5.79		20.0
22.0	4.61	4.10	4.32	4.80	4.08	4.44	5.01	4.74	5.36	5.05	4.44	4.96	4.73	4.77		22.0
24.0	3.78	3.28	3.49	3.96	3.26	3.61	4.17	3.81	4.33	4.21	3.61	4.12	3.90	3.93		24.0
26.0	3.09	2.59	2.81	3.27	2.58	2.92	3.47	2.99	3.50	3.52	2.92	3.43	3.21	3.24		26.0
28.0	2.51	2.02	2.23	2.69	2.00	2.34	2.89	2.27	2.78	2.93	2.34	2.85	2.62	2.66		28.0
30.0	2.02	1.53	1.73	2.19	1.51	1.85	2.39	1.65	2.16	2.44	1.85	2.35	2.13	2.16		30.0
32.0			1.31	1.76	1.09	1.42	1.96	1.13	1.65	2.00	1.42	1.92	1.70	1.73		32.0
34.0				1.39		1.05	1.58		1.24	1.63	1.05	1.54	1.32	1.36		34.0
36.0							1.25			1.30		1.21	0.99	1.03		36.0
38.0																38.0
40.0																40.0
42.0																42.0
44.0																44.0
46.0																46.0
48.0																48.0
50.0																50.0
52.0																52.0
54.0																54.0
56.0																56.0
Telescopic condition	II	0.00	92.00	46.00	46.00	92.00	46.00	46.00	92.00	46.00	46.00	92.00	46.00	92.00	100.00	II
	III	92.00	46.00	92.00	46.00	92.00	92.00	46.00	92.00	92.00	46.00	92.00	92.00	92.00	100.00	III
	IV	46.00	46.00	46.00	46.00	46.00	92.00	46.00	92.00	92.00	92.00	92.00	92.00	92.00	100.00	IV
	V	46.00	46.00	46.00	46.00	46.00	46.00	92.00	46.00	92.00	92.00	92.00	92.00	92.00	100.00	V
	VI	46.00	46.00	46.00	92.00	46.00	46.00	92.00	46.00	92.00	46.00	92.00	92.00	92.00	100.00	VI



**Prerequisites:**

- ① Boom operating conditions(fully extended boom length),min. length is 13.25m and max.length is 60m
- ② The span of outriggers is 7.6m×5.3m
- ③ 360°rotation is applied
- ④ Counterweight is 23.5T

Range ( m )	Main boom															Range ( m )	
	13.30	17.60	17.60	17.60	21.90	21.90	21.90	26.00	26.00	26.00	30.50	30.50	30.50	34.80	34.80		
3.0	90.00	90.00	86.00	62.00												3.0	
3.5	90.00	80.00	86.00	62.00												3.5	
4.0	80.00	80.00	80.00	62.00	62.00	65.00	57.50	65.00	58.00	55.70						4.0	
4.5	75.00	75.00	74.00	60.00	74.70	74.40	54.70	64.00	56.00	52.20	53.00	52.00	49.00			4.5	
5.0	72.50	72.50	71.00	59.00	69.00	68.00	51.80	63.00	53.60	48.70	52.00	50.20	48.50	43.30	41.30	5.0	
6.0	51.82	63.14	65.00	57.00	62.00	61.00	46.60	52.43	47.90	43.50	49.50	44.00	44.20	38.90	37.50	6.0	
7.0	38.68	38.18	39.54	40.06	38.61	39.69	41.43	39.29	43.60	39.30	47.10	39.40	40.00	34.60	33.80	7.0	
8.0	30.19	30.00	31.24	31.72	30.39	31.38	32.97	31.02	30.19	35.70	30.75	31.74	32.99	31.10	30.90	8.0	
9.0	24.58	24.37	25.54	25.99	24.74	25.67	27.16	25.33	24.55	32.20	25.08	26.00	27.18	25.70	26.73	9.0	
10.0	20.47	20.26	21.38	21.81	20.62	21.50	22.92	21.18	20.44	23.10	20.94	21.82	22.94	21.53	22.51	10.0	
12.0		14.67	15.71	16.11	15.00	15.83	17.15	15.52	14.83	17.31	15.31	16.12	17.16	15.86	16.77	12.0	
14.0		11.03	12.02	12.41	11.35	12.14	13.40	11.85	11.20	13.56	11.65	12.42	13.41	12.17	13.04	14.0	
16.0					8.79	9.55	10.78	9.28	8.64	10.92	9.08	9.83	10.79	9.58	10.42	16.0	
18.0					6.89	7.64	8.83	7.37	6.75	8.97	7.18	7.91	8.84	7.67	8.48	18.0	
20.0								5.90	5.29	7.47	5.71	6.43	7.34	6.20	6.99	20.0	
22.0								4.73	4.13	6.28	4.55	5.25	6.15	5.02	5.81	22.0	
24.0											3.60	4.30	5.18	4.07	4.85	24.0	
26.0											2.82	3.50	4.38	3.28	4.05	26.0	
28.0														2.62	3.38	28.0	
30.0														2.05	2.80	30.0	
32.0																32.0	
34.0																34.0	
36.0																36.0	
38.0																38.0	
40.0																40.0	
42.0																42.0	
44.0																44.0	
46.0																46.0	
48.0																48.0	
50.0																50.0	
52.0																52.0	
54.0																54.0	
56.0																56.0	
Telescopic condition	II	0.00	46.00	0.00	0.00	46.00	0.00	0.00	46.00	92.00	0.00	46.00	92.00	0.00	92.00	46.00	II
	III	0.00	0.00	0.00	0.00	46.00	46.00	0.00	46.00	46.00	0.00	46.00	46.00	46.00	46.00	46.00	III
	IV	0.00	0.00	46.00	0.00	0.00	46.00	0.00	46.00	0.00	46.00	46.00	46.00	46.00	46.00	46.00	IV
	V	0.00	0.00	0.00	46.00	0.00	0.00	46.00	0.00	0.00	46.00	46.00	0.00	46.00	46.00	46.00	V
	VI	0.00	0.00	0.00	0.00	0.00	0.00	46.00	0.00	0.00	46.00	0.00	0.00	46.00	0.00	46.00	VI

**Prerequisites:**

- ① Boom operating conditions(fully extended boom length),min. length is 13.25m and max.length is 60m
- ② The span of outriggers is 7.6m×5.3m
- ③ 360°rotation is applied
- ④ Counterweight is 23.5T

Range ( m )	Main boom															Range ( m )
	34.80	39.10	39.10	39.10	43.40	43.40	43.40	47.70	47.70	47.70	52.00	52.00	56.30	60.00		
3.0																3.0
3.5																3.5
4.0																4.0
4.5																4.5
5.0	38.80															5.0
6.0	35.50	33.20	32.80	31.10												6.0
7.0	32.20	30.30	29.90	28.90	25.00	23.50	22.20									7.0
8.0	28.90	27.50	27.00	26.70	24.00	22.60	21.00	21.50	20.50	18.30						8.0
9.0	27.06	25.00	24.50	24.50	23.40	21.80	20.80	20.50	19.60	17.40	17.70	15.40				9.0
10.0	22.82	22.18	22.46	22.60	22.50	20.60	19.50	19.00	18.70	16.50	17.00	14.80	13.10	11.40		10.0
12.0	17.05	16.46	16.71	17.27	16.44	16.85	17.40	16.59	16.90	14.70	15.70	13.50	12.40	10.80		12.0
14.0	13.31	12.74	12.99	13.52	12.73	13.12	13.75	12.87	13.37	13.10	13.12	12.30	11.60	10.20		14.0
16.0	10.68	10.14	10.37	10.88	10.12	10.50	11.11	10.26	10.74	11.16	10.50	11.06	10.81	9.60		16.0
18.0	8.74	8.21	8.44	8.93	8.19	8.56	9.15	8.33	8.79	9.20	8.56	9.10	8.87	8.90		18.0
20.0	7.24	6.72	6.95	7.43	6.71	7.07	7.64	6.84	7.29	7.69	7.07	7.60	7.37	7.40		20.0
22.0	6.05	5.54	5.76	6.24	5.53	5.88	6.45	5.66	6.10	6.50	5.88	6.40	6.17	6.21		22.0
24.0	5.09	4.58	4.80	5.27	4.57	4.92	5.48	4.70	5.14	5.52	4.92	5.43	5.21	5.24		24.0
26.0	4.29	3.79	4.00	4.47	3.77	4.12	4.67	3.90	4.34	4.72	4.12	4.63	4.40	4.44		26.0
28.0	3.61	3.12	3.33	3.79	3.10	3.45	3.99	3.23	3.66	4.04	3.45	3.95	3.73	3.76		28.0
30.0	3.04	2.55	2.76	3.21	2.53	2.87	3.41	2.66	3.08	3.46	2.87	3.37	3.15	3.18		30.0
32.0		2.05	2.26	2.72	2.04	2.37	2.91	2.16	2.59	2.96	2.37	2.87	2.65	2.69		32.0
34.0		1.62	1.83	2.28	1.61	1.94	2.48	1.73	2.15	2.52	1.94	2.43	2.22	2.25		34.0
36.0					1.23	1.56	2.09	1.35	1.77	2.13	1.56	2.05	1.83	1.87		36.0
38.0								1.01	1.43	1.79	1.22	1.71	1.49	1.52		38.0
40.0									1.13	1.49		1.40	1.19	1.22		40.0
42.0												1.13				42.0
44.0																44.0
46.0																46.0
48.0																48.0
50.0																50.0
52.0																52.0
54.0																54.0
56.0																56.0
Telescopic condition	II	0.00	92.00	46.00	46.00	92.00	46.00	46.00	92.00	46.00	46.00	92.00	46.00	92.00	100.00	II
	III	92.00	46.00	92.00	46.00	92.00	92.00	46.00	92.00	92.00	46.00	92.00	92.00	92.00	100.00	III
	IV	46.00	46.00	46.00	46.00	46.00	92.00	46.00	92.00	92.00	92.00	92.00	92.00	92.00	100.00	IV
	V	46.00	46.00	46.00	46.00	46.00	46.00	92.00	46.00	92.00	92.00	92.00	92.00	92.00	100.00	V
	VI	46.00	46.00	46.00	92.00	46.00	46.00	92.00	46.00	92.00	92.00	46.00	92.00	92.00	100.00	VI

**Prerequisites:**

- ① Boom operating conditions(fully extended boom length),min. length is 13.25m and max.length is 60m
- ② The span of outriggers is 7.6m×5.3m
- ③ 360°rotation is applied
- ④ Counterweight is 32.5T

Range ( m )	Main boom															Range ( m )	
	13.30	17.60	17.60	17.60	21.90	21.90	21.90	26.00	26.00	26.00	30.50	30.50	30.50	34.80	34.80		
3.0	100.00	91.00	86.00	82.00												3.0	
3.5	100.00	87.00	86.00	82.00												3.5	
4.0	97.00	85.00	82.00	82.00	80.50	78.40	57.50	65.00	58.00	55.70						4.0	
4.5	89.00	81.00	74.00	60.00	74.70	74.40	54.70	64.00	56.00	52.20						4.5	
5.0	80.00	72.50	71.00	59.00	69.00	68.00	51.80	63.00	53.60	48.70	52.00	50.20	48.50	43.30	41.30	5.0	
6.0	62.41	61.76	63.30	57.00	62.00	61.00	46.60	60.00	47.90	43.50	49.50	44.00	44.20	38.90	37.50	6.0	
7.0	46.86	46.36	59.00	56.00	46.79	47.87	42.20	47.47	43.60	39.30	47.10	39.40	40.00	34.60	33.80	7.0	
8.0	36.86	36.67	37.91	38.39	37.06	38.05	39.10	37.68	36.85	35.70	42.60	35.30	36.20	31.10	30.90	8.0	
9.0	35.74	30.00	31.17	31.62	30.36	31.30	32.79	30.95	30.18	32.80	38.90	32.00	33.20	28.20	28.10	9.0	
10.0	29.77	25.13	26.24	26.67	25.48	26.37	27.79	26.04	25.30	27.96	25.81	29.50	30.60	25.40	25.90	10.0	
12.0		18.50	19.54	19.94	18.83	19.66	20.98	19.35	18.66	21.14	19.14	19.95	20.99	21.90	22.40	12.0	
14.0		14.18	15.18	15.57	14.51	15.30	16.56	15.01	14.35	16.71	14.80	15.58	16.57	18.80	19.60	14.0	
16.0					11.48	12.24	13.46	11.96	11.33	13.61	11.76	12.51	13.47	12.27	13.11	16.0	
18.0					9.23	9.98	11.17	9.71	9.09	11.31	9.51	10.24	11.18	10.01	10.82	18.0	
20.0								7.97	7.36	9.54	7.78	8.50	9.41	8.26	9.06	20.0	
22.0								6.59	5.99	8.14	6.40	7.11	8.01	6.88	7.66	22.0	
24.0											5.28	5.98	6.87	5.75	6.53	24.0	
26.0											4.35	5.04	5.92	4.82	5.59	26.0	
28.0														4.03	4.79	28.0	
30.0														3.36	4.12	30.0	
32.0																32.0	
34.0																34.0	
36.0																36.0	
38.0																38.0	
40.0																40.0	
42.0																42.0	
44.0																44.0	
46.0																46.0	
48.0																48.0	
50.0																50.0	
52.0																52.0	
54.0																54.0	
56.0																56.0	
Telescopic condition	II	0.00	46.00	0.00	0.00	46.00	0.00	0.00	46.00	92.00	0.00	46.00	92.00	0.00	92.00	46.00	II
	III	0.00	0.00	0.00	0.00	46.00	46.00	0.00	46.00	46.00	0.00	46.00	46.00	46.00	46.00	46.00	III
	IV	0.00	0.00	46.00	0.00	0.00	46.00	0.00	46.00	0.00	46.00	46.00	46.00	46.00	46.00	46.00	IV
	V	0.00	0.00	0.00	46.00	0.00	0.00	46.00	0.00	0.00	46.00	46.00	0.00	46.00	46.00	46.00	V
	VI	0.00	0.00	0.00	0.00	0.00	0.00	46.00	0.00	0.00	46.00	0.00	0.00	46.00	0.00	46.00	VI

**Prerequisites:**

- ① Boom operating conditions(fully extended boom length),min. length is 13.25m and max.length is 60m
- ② The span of outriggers is 7.6m×5.3m
- ③ 360°rotation is applied
- ④ Counterweight is 32.5T

Range ( m )	Main boom														Range ( m )	
	34.80	39.10	39.10	39.10	43.40	43.40	43.40	47.70	47.70	47.70	52.00	52.00	56.30	60.00		
3.0																3.0
3.5																3.5
4.0																4.0
4.5																4.5
5.0	38.80															5.0
6.0	35.50	33.20	32.80	31.10												6.0
7.0	32.20	30.30	29.90	28.90	25.00	23.50	22.20									7.0
8.0	28.90	27.50	27.00	26.70	24.00	22.60	21.00	21.50	20.50	18.30						8.0
9.0	26.50	25.00	24.50	24.50	23.40	21.80	20.80	20.50	19.60	17.40	17.70	15.40				9.0
10.0	24.30	23.20	22.60	22.60	22.50	20.60	19.50	19.00	18.70	16.50	17.00	14.80	13.10	11.40		10.0
12.0	21.20	19.60	19.40	19.70	20.10	19.50	17.40	18.00	16.90	14.70	15.70	13.50	12.40	10.80		12.0
14.0	18.40	17.10	16.80	17.20	17.60	17.80	15.50	17.00	15.40	13.10	14.30	12.30	11.60	10.20		14.0
16.0	16.30	14.80	14.80	15.40	15.80	15.90	14.00	15.80	13.80	11.80	13.20	11.30	10.90	9.60		16.0
18.0	11.08	13.20	13.10	13.80	10.53	10.90	12.60	10.67	12.50	10.70	12.00	10.40	10.10	9.00		18.0
20.0	9.31	8.79	9.01	9.50	8.78	9.14	11.40	8.91	11.40	9.70	11.20	9.60	9.50	8.30		20.0
22.0	7.91	7.40	7.62	8.10	7.38	7.74	10.40	7.51	7.96	8.90	7.74	8.80	8.80	7.80		22.0
24.0	6.77	6.27	6.48	6.95	6.25	6.60	7.16	6.38	6.82	8.20	6.60	8.20	8.10	7.30		24.0
26.0	5.83	5.33	5.54	6.01	5.31	5.66	6.21	5.44	5.87	7.50	5.66	7.60	5.94	6.80		26.0
28.0	5.03	4.54	4.75	5.21	4.52	4.86	5.41	4.65	5.08	5.45	4.86	5.37	5.14	6.40		28.0
30.0	4.35	3.86	4.07	4.53	3.85	4.19	4.73	3.97	4.40	4.77	4.18	4.68	4.46	4.50		30.0
32.0		3.28	3.48	3.94	3.26	3.60	4.14	3.39	3.81	4.18	3.60	4.09	3.88	3.91		32.0
34.0		2.77	2.97	3.43	2.75	3.09	3.62	2.88	3.30	3.67	3.09	3.58	3.36	3.40		34.0
36.0					2.31	2.64	3.17	2.43	2.85	3.21	2.64	3.12	2.91	2.94		36.0
38.0								2.03	2.45	2.81	2.24	2.72	2.51	2.54		38.0
40.0								1.67	2.09	2.45	1.88	2.36	2.15	2.19		40.0
42.0											1.56	2.04	1.83	1.86		42.0
44.0											1.27	1.75	1.54	1.57		44.0
46.0																46.0
48.0																48.0
50.0																50.0
52.0																52.0
54.0																54.0
56.0																56.0
Telescopic condition	II	0.00	92.00	46.00	46.00	92.00	46.00	46.00	92.00	46.00	46.00	92.00	46.00	92.00	100.00	II
	III	92.00	46.00	92.00	46.00	92.00	92.00	46.00	92.00	92.00	46.00	92.00	92.00	92.00	100.00	III
	IV	46.00	46.00	46.00	46.00	46.00	92.00	46.00	92.00	92.00	92.00	92.00	92.00	92.00	100.00	IV
	V	46.00	46.00	46.00	46.00	46.00	46.00	92.00	46.00	92.00	92.00	92.00	92.00	92.00	100.00	V
	VI	46.00	46.00	46.00	92.00	46.00	46.00	92.00	46.00	92.00	46.00	92.00	92.00	92.00	100.00	VI



Unit:t

**Prerequisites:**  
 ① Boom operating conditions(fully extended boom length+jib length), max.length is 60m+10.7m  
 ② The span of outriggers is 7.6m×7.6m  
 ③ 360°rotation is applied  
 ④ Counterweight is 32.5T

Main boom length	Main boom+Jib											
	43.3m			43.3m			47.6m			47.6m		
Main boom elevation(°)	0°	15°	30°	0°	15°	30°	0°	15°	30°	0°	15°	30°
78	7.0	5.3	3.5	7.0	5.3	3.5	7.0	5.3	3.5	7.0	5.3	3.5
76	6.5	4.9	3.4	6.5	4.9	3.4	6.5	4.9	3.4	6.5	4.9	3.4
74	6.2	4.6	3.2	6.2	4.6	3.2	6.2	4.6	3.2	6.2	4.6	3.2
72	5.9	4.3	3.1	5.9	4.3	3.1	5.9	4.3	3.1	5.9	4.3	3.1
70	5.7	4.0	3.0	5.7	4.0	3.0	5.7	4.0	3.0	5.7	4.0	3.0
68	5.5	3.9	2.9	5.5	3.9	2.9	5.5	3.9	2.9	5.5	3.9	2.9
66	5.3	3.7	2.8	5.3	3.7	2.8	5.3	3.7	2.8	5.3	3.7	2.8
64	5.0	3.5	2.8	5.0	3.5	2.8	5.0	3.5	2.8	5.0	3.5	2.8
62	4.7	3.3	2.7	4.7	3.3	2.7	4.7	3.3	2.7	4.7	3.3	2.7
60	4.4	3.2	2.6	4.4	3.2	2.6	4.4	3.2	2.6	4.4	3.2	2.6
58	4.1	3.1	2.6	4.1	3.1	2.6	4.1	3.1	2.6	4.1	3.1	2.6
56	3.9	3.0	2.5	3.9	3.0	2.5	3.9	3.0	2.5	3.9	3.0	2.5
54	3.7	2.9	2.5	3.7	2.9	2.5	3.7	2.9	2.5	3.7	2.9	2.5
52	3.5	2.8	2.5	3.5	2.8	2.5	3.5	2.8	2.5	3.5	2.8	2.5
50	3.4	2.8	2.4	3.4	2.8	2.4	3.4	2.8	2.4	3.4	2.8	2.4
48	3.2	2.7	2.4	3.2	2.7	2.4	3.2	2.7	2.4	3.2	2.7	2.4
46	3.1	2.6	2.4	3.1	2.6	2.4	3.1	2.6	2.4	3.1	2.6	2.4
44	3.0	2.6	2.3	3.0	2.6	2.3	3.0	2.6	2.3	3.0	2.6	2.3
42	3.0	2.5	2.3	3.0	2.5	2.3	3.0	2.5	2.3	2.9	2.5	2.3
40	2.9	2.5	2.3	2.9	2.5	2.3	2.9	2.5	2.3	2.7	2.5	2.3
38	2.8	2.5	2.3	2.8	2.5	2.3	2.8	2.5	2.3	2.5	2.3	2.3
36	2.7	2.4	2.3	2.7	2.4	2.3	2.6	2.4	2.3	2.3	2.0	2.3
34	2.7	2.4	1.5	2.7	2.4	1.5	2.4	2.3	1.5	2.1	2.0	2.1
32	2.6	2.4	1.0	2.6	2.4	1.0	2.2	2.2	1.0	2.0	1.9	1.5
30	2.6	2.4	1.0	2.6	2.4	1.0	2.1	2.0	1.0	1.8	1.8	1.0
II	46			46			46			46		
III	92			46			92			46		
IV	92			46			92			92		
V	46			92			92			92		
VI	46			92			46			92		

Unit:t

**Prerequisites:**  
 ① Boom operating conditions(fully extended boom length+jib length), max.length is 60m+10.7m  
 ② The span of outriggers is 7.6m×7.6m  
 ③ 360°rotation is applied  
 ④ Counterweight is 32.5T

Main boom length	Main boom+Jib											
	52m			52m			56.2m			60m		
Main boom elevation(°)	0°	15°	30°	0°	15°	30°	0°	15°	30°	0°	15°	30°
78	7.0	5.3	3.5	7.0	5.3	3.5	7.0	5.3	3.5	7.0	5.3	3.5
76	6.5	4.9	3.4	6.5	4.9	3.4	6.5	4.9	3.4	6.5	4.9	3.4
74	6.2	4.6	3.2	6.2	4.6	3.2	6.2	4.6	3.2	6.2	4.6	3.2
72	5.9	4.3	3.1	5.9	4.3	3.1	5.9	4.3	3.1	5.9	4.3	3.1
70	5.7	4.0	3.0	5.7	4.0	3.0	5.7	4.0	3.0	5.7	4.0	3.0
68	5.5	3.9	2.9	5.5	3.9	2.9	5.5	3.9	2.9	5.5	3.9	2.9
66	5.3	3.7	2.8	5.3	3.7	2.8	5.3	3.7	2.8	5.3	3.7	2.8
64	5.0	3.5	2.8	5.0	3.5	2.8	5.0	3.5	2.8	5.0	3.5	2.8
62	4.7	3.3	2.7	4.7	3.3	2.7	4.7	3.3	2.7	4.5	3.3	2.7
60	4.4	3.2	2.6	4.4	3.2	2.6	4.4	3.2	2.6	3.9	3.2	2.6
58	4.1	3.1	2.6	4.1	3.1	2.6	4.0	3.1	2.6	3.4	3.0	2.6
56	3.9	3.0	2.5	3.9	3.0	2.5	3.5	3.0	2.5	3.0	2.7	2.5
54	3.5	2.9	2.5	3.7	2.9	2.5	3.0	2.9	2.5	2.6	2.4	2.2
52	3.1	2.8	2.5	3.5	2.8	2.5	2.8	2.5	2.4	2.2	2.1	1.9
50	2.9	2.6	2.4	3.2	2.8	2.4	2.4	2.2	2.1	1.9	1.8	1.7
48	2.5	2.3	2.2	3.0	2.7	2.4	2.1	2.0	1.8	1.7	1.5	1.4
46	2.2	2.1	2.0	2.7	2.5	2.4	1.9	1.7	1.6	1.4	1.3	1.2
44	2.0	1.8	1.7	2.4	2.2	2.1	1.6	1.5	1.4	1.2	1.1	1.0
42	1.7	1.6	1.5	2.2	2.0	1.9	1.4	1.3	1.2	1.0	1.0	
40	1.5	1.4	1.4	2.0	1.8	1.8	1.2	1.1	1.1			
38	1.3	1.3	1.2	1.8	1.7	1.6	1.0	1.0	1.0			
36	1.2	1.1	1.1	1.6	1.5	1.5						
34	1.0	1.0	1.0	1.5	1.4	1.3						
32				1.3	1.2	1.0						
30				1.2	1.1							
II	92			46			92			100		
III	92			92			92			100		
IV	92			92			92			100		
V	92			92			92			100		
VI	46			92			92			100		

**Prerequisites:**

- ① Boom operating conditions(fully extended boom length+jib length), max.length is 60m+18m
- ② The span of outriggers is 7.6m×7.6m
- ③ 360°rotation is applied
- ④ Counterweight is 32.5T

Main boom length	Main boom+Jib											
	43.3m			43.3m			47.6m			47.6m		
Main boom elevation(°)	0°	15°	30°	0°	15°	30°	0°	15°	30°	0°	15°	30°
78	5.8	3.5	2.5	5.8	3.5	2.5	5.8	3.5	2.5	5.8	3.5	2.5
76	5.3	3.3	2.3	5.3	3.3	2.3	5.3	3.3	2.3	5.3	3.3	2.3
74	4.9	3.2	2.3	4.9	3.2	2.3	4.9	3.2	2.3	4.9	3.2	2.3
72	4.6	3.0	2.2	4.6	3.0	2.2	4.6	3.0	2.2	4.6	3.0	2.2
70	4.3	2.9	2.2	4.3	2.9	2.2	4.3	2.9	2.2	4.3	2.9	2.2
68	4.0	2.8	2.0	4.0	2.8	2.0	4.0	2.8	2.0	4.0	2.8	2.0
66	3.9	2.8	2.0	3.9	2.8	2.0	3.9	2.8	2.0	3.9	2.8	2.0
64	3.8	2.6	2.0	3.8	2.6	2.0	3.8	2.6	2.0	3.8	2.6	2.0
62	3.6	2.5	1.9	3.6	2.5	1.9	3.6	2.5	1.9	3.6	2.5	1.9
60	3.5	2.5	1.9	3.5	2.5	1.9	3.5	2.5	1.9	3.5	2.5	1.9
58	3.3	2.3	1.9	3.3	2.3	1.9	3.3	2.3	1.9	3.3	2.3	1.9
56	3.2	2.3	1.9	3.2	2.3	1.9	3.2	2.3	1.9	3.2	2.3	1.9
54	3.0	2.3	1.9	3.0	2.3	1.9	3.0	2.3	1.9	3.0	2.3	1.9
52	3.0	2.2	1.8	3.0	2.2	1.8	3.0	2.2	1.8	3.0	2.2	1.8
50	2.9	2.2	1.8	2.9	2.2	1.8	2.9	2.2	1.8	2.9	2.2	1.8
48	2.8	2.2	1.8	2.8	2.2	1.8	2.8	2.2	1.8	2.8	2.2	1.8
46	2.8	2.2	1.8	2.8	2.2	1.8	2.8	2.2	1.8	2.8	2.2	1.8
44	2.6	2.0	1.8	2.6	2.0	1.8	2.6	2.0	1.8	2.6	2.0	1.8
42	2.6	2.0	1.8	2.6	2.0	1.8	2.6	2.0	1.8	2.6	2.0	1.8
40	2.5	2.0	1.8	2.5	2.0	1.8	2.4	2.0	1.8	2.5	2.0	1.8
38	2.4	2.0	1.8	2.4	2.0	1.8	2.2	2.0	1.8	2.4	2.0	1.8
36	2.4	2.0	1.7	2.4	2.0	1.7	2.0	1.9	1.7	2.3	2.0	1.7
34	2.3	2.0	1.0	2.3	2.0	1.0	1.8	1.7	1.0	2.1	2.0	1.0
32	2.2	2.0	1.0	2.3	2.0	1.0	1.7	1.6	1.0	2.0	1.9	1.0
30	2.0	1.9	1.0	2.2	1.9	1.0	1.5	1.5	1.0	1.8	1.8	
II	46			46			46			46		
III	92			46			92			46		
IV	92			46			92			92		
V	46			92			92			92		
VI	46			92			46			92		

**Prerequisites:**

- ① Boom operating conditions(fully extended boom length+jib length), max.length is 60m+18m
- ② The span of outriggers is 7.6m×7.6m
- ③ 360°rotation is applied
- ④ Counterweight is 32.5T

Main boom length	Main boom+Jib											
	52m			52m			56.2m			60m		
Main boom elevation(°)	0°	15°	30°	0°	15°	30°	0°	15°	30°	0°	15°	30°
78	5.8	3.5	2.5	5.8	3.5	2.5	5.8	3.5	2.5	5.0	3.5	2.5
76	5.3	3.3	2.3	5.3	3.3	2.3	5.3	3.3	2.3	5.0	3.3	2.3
74	4.9	3.2	2.3	4.9	3.2	2.3	4.9	3.2	2.3	4.9	3.2	2.3
72	4.6	3.0	2.2	4.6	3.0	2.2	4.6	3.0	2.2	4.6	3.0	2.2
70	4.3	2.9	2.2	4.3	2.9	2.2	4.3	2.9	2.2	4.3	2.9	2.2
68	4.0	2.8	2.0	4.0	2.8	2.0	4.0	2.8	2.0	4.0	2.8	2.0
66	3.9	2.8	2.0	3.9	2.8	2.0	3.9	2.8	2.0	3.9	2.8	2.0
64	3.8	2.6	2.0	3.8	2.6	2.0	3.8	2.6	2.0	3.8	2.6	2.0
62	3.6	2.5	1.9	3.6	2.5	1.9	3.6	2.5	1.9	3.6	2.5	1.9
60	3.5	2.5	1.9	3.5	2.5	1.9	3.5	2.5	1.9	3.5	2.5	1.9
58	3.3	2.3	1.9	3.3	2.3	1.9	3.3	2.3	1.9	3.3	2.3	1.9
56	3.2	2.3	1.9	3.2	2.3	1.9	3.2	2.3	1.9	3.0	2.3	1.9
54	3.0	2.3	1.9	3.0	2.3	1.9	3.0	2.3	1.9	2.6	2.3	1.9
52	3.0	2.2	1.8	3.0	2.2	1.8	2.8	2.2	1.8	2.2	2.1	1.8
50	2.9	2.2	1.8	2.9	2.2	1.8	2.4	2.2	1.8	1.9	1.8	1.7
48	2.5	2.2	1.8	2.8	2.2	1.8	2.1	2.0	1.8	1.7	1.5	1.4
46	2.2	2.1	1.8	2.7	2.2	1.8	1.9	1.7	1.6	1.4	1.3	1.2
44	2.0	1.8	1.7	2.4	2.0	1.8	1.6	1.5	1.4	1.2	1.1	1.0
42	1.7	1.6	1.5	2.2	2.0	1.8	1.4	1.3	1.2	1.0		
40	1.5	1.4	1.4	2.0	1.8	1.8	1.2	1.1	1.1			
38	1.3	1.3	1.2	1.8	1.7	1.6	1.0					
36	1.2	1.1	1.1	1.6	1.5	1.5						
34	1.0	1.0	1.0	1.5	1.4	1.0						
32	1.0			1.3	1.2							
30				1.2	1.1							
II	92			46			92			100		
III	92			92			92			100		
IV	92			92			92			100		
V	92			92			92			100		
VI	46			92			92			100		

**Prerequisites:**

- ① Boom operating conditions(fully extended boom length),min.length is 13.25m and max.length is 60m
- ② The span of outriggers is 7.6m×7.6m
- ③ 360°rotation is applied
- ④ Counterweight is 8.5T,counterweight cylinder extend 860mm

Range ( m )	Main boom														Range ( m )		
	13.25	17.50	17.50	17.50	21.80	21.80	21.80	26.10	26.10	26.10	30.50	30.50	30.50	34.80		34.80	
3.00	100.00	91.00	86.00	82.00												3.00	
3.50	100.00	87.00	86.00	82.00												3.50	
4.00	97.00	85.00	82.00	82.00	80.50	78.40	57.50	65.00	58.00	55.70						4.00	
4.50	89.00	81.00	74.00	60.00	74.70	74.40	54.70	64.00	56.00	52.20	52.00	49.00	52.00			4.50	
5.00	83.00	72.50	71.00	59.00	69.00	68.00	51.80	63.00	53.60	48.70	51.00	48.50	50.20	43.30	41.30	5.00	
6.00	72.00	67.00	65.00	57.00	62.00	61.00	46.60	60.00	47.90	43.50	49.00	44.20	44.00	38.90	37.50	6.00	
7.00	58.92	58.06	59.76	56.00	55.00	55.00	42.20	57.40	43.60	39.30	47.10	40.00	39.40	34.60	33.80	7.00	
8.00	45.29	44.33	45.93	45.43	44.23	44.33	39.10	46.30	40.20	35.70	42.60	36.20	33.83	31.10	30.90	8.00	
9.00	33.02	34.12	35.12	34.92	33.52	33.72	36.82	37.22	34.58	32.80	35.12	33.20	32.52	28.20	28.10	9.00	
10.00	25.87	26.77	27.87	28.27	26.47	27.27	29.57	29.87	27.47	27.57	28.47	29.67	25.87	25.40	25.90	10.00	
12.00		17.97	18.97	19.57	17.77	18.37	20.67	20.97	18.62	19.23	19.67	20.77	21.57	19.27	20.57	12.00	
14.00		12.94	13.44	14.04	12.64	13.24	15.64	18.64	13.39	14.00	14.24	15.74	12.74	14.04	15.24	14.00	
16.00					9.32	9.84	12.09	12.26	10.05	12.22	10.86	14.26	9.56	10.46	11.66	16.00	
18.00					6.83	7.33	9.47	9.78	7.54	8.05	8.35	9.68	7.20	8.05	9.17	18.00	
20.00								7.90	6.71	6.15	6.47	7.69	5.45	6.16	7.28	20.00	
22.00								6.41	4.29	4.69	5.10	6.22	4.11	4.81	5.81	22.00	
24.00											3.95	5.07	2.58	3.64	4.66	24.00	
26.00											2.91	4.17	2.36	2.73	3.73	26.00	
28.00														1.87	2.91	28.00	
30.00															2.27	30.00	
32.00																32.00	
34.00																34.00	
Number of lines	12	11	11	11	9	9	9	8	8	8	6	6	6	5	5	Number of lines	
Telescopic condition	II	0	46	0	0	46	0	0	46	92	0	46	0	92	92	46	Telescopic condition
	III	0	0	0	0	46	46	0	46	46	0	46	46	46	46	46	
	IV	0	0	46	0	0	46	0	46	0	46	46	46	46	46	46	
	V	0	0	0	46	0	0	46	0	0	46	46	46	0	46	46	
	VI	0	0	0	0	0	0	46	0	0	46	0	46	0	0	46	
Hooks	110t hook(1815kg)										50t hook(580kg)					Hooks	

**Prerequisites:**

- ① Boom operating conditions(fully extended boom length),min.length is 13.25m and max.length is 60m
- ② The span of outriggers is 7.6m×7.6m
- ③ 360°rotation is applied
- ④ Counterweight is 8.5T,counterweight cylinder extend 860mm

Range ( m )	Main boom														Range ( m )	
	34.80	39.00	39.00	39.00	43.30	43.30	43.30	47.60	47.60	47.60	52.00	52.00	56.20	60.00		
3.00																3.00
3.50																3.50
4.00																4.00
4.50																4.50
5.00	38.80															5.00
6.00	35.50	33.20	32.80	31.10												6.00
7.00	32.20	30.30	29.90	28.90	25.00	23.50	22.20									7.00
8.00	28.90	27.50	27.00	26.70	24.00	22.60	21.00	21.50	20.50	18.30						8.00
9.00	26.50	25.00	24.50	24.50	23.40	21.80	20.80	20.50	19.60	17.40	17.70	15.40				9.00
10.00	24.30	23.20	22.60	22.60	22.50	20.60	19.50	19.00	18.70	16.50	17.00	14.80	13.10	11.40		10.00
12.00	20.57	20.17	19.40	19.70	19.77	19.50	17.40	18.00	16.90	14.70	15.70	13.50	12.40	10.80		12.00
14.00	15.54	14.74	15.04	15.64	14.84	15.54	15.94	15.54	15.44	13.10	14.30	12.30	11.60	10.20		14.00
16.00	12.06	11.26	11.46	12.26	11.26	11.76	12.66	11.46	12.16	11.80	11.86	11.30	10.90	9.60		16.00
18.00	9.48	8.70	9.10	9.80	8.80	9.30	10.40	9.00	9.70	10.00	9.40	9.90	9.60	9.00		18.00
20.00	7.59	6.85	7.15	7.85	6.85	7.35	8.25	7.05	7.85	8.35	7.45	8.25	7.95	7.95		20.00
22.00	6.12	5.51	5.81	6.41	5.51	5.91	6.71	5.61	6.41	6.81	6.01	6.61	6.31	6.41		22.00
24.00	4.98	4.38	4.58	5.32	4.38	4.78	5.58	4.48	5.08	5.58	4.78	5.48	5.18	5.28		24.00
26.00	4.06	3.42	3.66	4.24	3.46	3.86	4.56	3.56	4.16	4.66	3.83	4.56	4.26	4.36		26.00
28.00	3.24	2.54	2.89	3.50	2.59	3.09	3.84	2.82	3.44	3.84	3.12	3.64	3.39	3.44		28.00
30.00	2.52	1.97	2.17	2.77	1.95	2.36	3.12	2.07	2.72	3.22	2.36	3.02	2.77	2.82		30.00
32.00			1.64	2.25		1.83	2.60	1.50	2.20	2.60	1.83	2.46	2.24	2.25		32.00
34.00				1.72			2.09		1.69	2.14		1.94	1.72	1.74		34.00
Number of lines	5	4	4	4	3	3	3	3	3	3	2	2	2	2	Number of lines	
Telescopic condition	II	0	92	46	46	92	46	46	92	46	46	92	46	92	100	Telescopic condition
	III	92	46	92	46	92	92	46	92	92	46	92	92	92	100	
	IV	46	46	46	46	46	92	46	92	92	92	92	92	92	100	
	V	46	46	46	46	46	46	92	46	92	92	92	92	92	100	
	VI	46	46	46	92	46	46	92	46	92	92	46	92	92	100	
Hooks	50t hook(580kg)														Hooks	



**Prerequisites:**

- ① Boom operating conditions(fully extended boom length),min.length is 13.25m and max.length is 60m
- ② The span of outriggers is 7.6m×7.6m
- ③ 360°rotation is applied
- ④ Counterweight is 16.5T,counterweight cylinder extend 860mm

Range ( m )	Main boom														Range ( m )		
	13.25	17.50	17.50	17.50	21.80	21.80	21.80	26.10	26.10	26.10	30.50	30.50	30.50	34.80		34.80	
3	100.00	91.00	86.00	82.00												3	
3.5	100.00	87.00	86.00	82.00												3.5	
4	97.00	85.00	82.00	82.00	80.50	78.40	57.50	65.00	58.00	55.70						4	
4.5	89.00	81.00	74.00	60.00	74.70	74.40	54.70	64.00	56.00	52.20	53.00	52.00	49.00			4.5	
5	83.00	72.50	71.00	59.00	69.00	68.00	51.80	63.00	53.60	48.70	52.00	50.20	48.50	43.30	41.30	5	
6	72.00	67.00	65.00	57.00	62.00	61.00	46.60	60.00	47.90	43.50	49.50	44.00	44.20	38.90	37.50	6	
7	59.00	60.00	59.00	56.00	55.00	55.00	42.20	57.40	43.60	39.30	47.10	39.40	40.00	34.60	33.80	7	
8	54.49	51.00	50.00	50.00	50.60	50.00	39.10	51.70	40.20	35.70	42.60	35.30	36.20	31.10	30.90	8	
9	43.47	43.97	44.67	42.00	43.67	43.17	36.10	46.07	37.30	32.80	38.90	32.00	33.20	28.20	28.10	9	
10	34.88	35.68	36.58	37.28	35.38	36.18	33.50	38.38	34.20	30.30	35.40	29.50	30.60	25.40	25.90	10	
12		24.70	25.50	26.10	24.40	25.10	27.00	27.30	25.20	25.90	26.30	25.50	27.10	21.90	22.40	12	
14		18.06	18.86	19.36	17.86	18.56	20.86	21.16	18.76	19.26	19.66	18.96	20.96	19.26	20.46	14	
16					13.59	14.09	16.39	16.69	14.29	14.89	15.19	14.49	16.49	14.89	16.09	16	
18					10.55	11.07	13.27	13.47	11.27	11.77	12.07	11.47	13.37	11.77	12.87	18	
20								11.18	9.02	9.43	9.74	9.12	11.08	9.53	10.56	20	
22								9.36	7.20	7.61	8.02	7.40	9.15	7.71	8.74	22	
24											6.52	5.90	7.76	6.21	7.24	24	
26											5.34	4.72	6.47	5.03	6.06	26	
28														4.06	5.09	28	
30														3.20	4.23	30	
32																32	
34																34	
36																36	
38																38	
40																40	
42																42	
Number of lines	12	11	11	11	9	9	9	8	8	8	7	7	7	5	5	Number of lines	
Telescopic condition	II	0	46	0	0	46	0	0	46	92	0	46	92	0	92	46	Telescopic condition
	III	0	0	0	0	46	46	0	46	46	0	46	46	46	46	46	
	IV	0	0	46	0	0	46	0	46	0	46	46	46	46	46	46	
	V	0	0	0	46	0	0	46	0	0	46	46	0	46	46	46	
	VI	0	0	0	0	0	0	46	0	0	46	0	0	46	0	46	
	Hooks	110t hook(1815kg)							50t hook(580kg)							Hooks	

**Prerequisites:**

- ① Boom operating conditions(fully extended boom length),min.length is 13.25m and max.length is 60m
- ② The span of outriggers is 7.6m×7.6m
- ③ 360°rotation is applied
- ④ Counterweight is 16.5T,counterweight cylinder extend 860mm

Range ( m )	Main boom														Range ( m )	
	34.80	39.00	39.00	39.00	43.30	43.30	43.30	47.60	47.60	47.60	52.00	52.00	56.20	60.00		
3																3
3.5																3.5
4																4
4.5																4.5
5	38.80															5
6	35.50	33.20	32.80	31.10												6
7	32.20	30.30	29.90	28.90	25.00	23.50	22.20									7
8	28.90	27.50	27.00	26.70	24.00	22.60	21.00	21.50	20.50	18.30						8
9	26.50	25.00	24.50	24.50	23.40	21.80	20.80	20.50	19.60	17.40	17.70	15.40				9
10	24.30	23.20	22.60	22.60	22.50	20.60	19.50	19.00	18.70	16.50	17.00	14.80	13.10	11.40		10
12	21.20	19.60	19.40	19.70	20.10	19.50	17.40	18.00	16.90	14.70	15.70	13.50	12.40	10.80		12
14	18.40	17.10	16.80	17.20	17.60	17.80	15.50	17.00	15.40	13.10	14.30	12.30	11.60	10.20		14
16	16.39	14.80	15.59	15.40	15.29	15.79	14.00	15.49	13.80	11.80	13.20	11.30	10.90	9.60		16
18	13.27	12.57	12.57	13.17	12.17	12.77	12.60	12.37	13.07	10.70	12.00	10.40	10.10	9.00		18
20	10.78	10.25	10.28	10.88	9.98	10.38	11.18	10.08	10.78	9.70	10.48	9.60	9.50	8.30		20
22	9.05	8.43	8.41	9.11	8.21	8.61	9.41	8.31	9.01	8.90	8.71	9.31	9.01	7.80		22
24	7.55	6.93	7.05	7.65	6.75	7.25	7.95	6.95	7.55	8.05	7.25	7.95	7.65	7.65		24
26	6.37	5.75	6.06	6.68	5.60	6.10	6.80	5.80	6.40	6.90	6.10	6.70	6.40	6.50		26
28	5.36	4.78	4.99	5.61	4.78	5.19	6.06	4.86	5.36	5.86	5.16	5.76	5.46	5.56		28
30	4.54	3.92	4.23	4.84	3.92	4.33	5.05	4.12	4.52	5.02	4.32	4.92	4.62	4.72		30
32		3.17	3.48	4.09	3.17	3.68	4.40	3.37	3.89	4.29	3.68	4.19	3.99	3.99		32
34		2.53	2.84	3.46	2.53	3.04	3.76	2.73	3.35	3.76	3.04	3.66	3.46	3.46		34
36					1.99	2.51	3.23	2.20	2.82	3.23	2.51	3.13	2.92	2.92		36
38								1.77	2.28	2.80	2.08	2.69	2.39	2.49		38
40									1.85	2.37	1.64	2.26	1.95	2.06		40
42												1.83	1.52	1.62		42
Number of lines	5	4	4	4	3	3	3	3	3	3	2	2	2	2	Number of lines	
Telescopic condition	II	0	92	46	46	92	46	46	92	46	46	92	46	92	100	Telescopic condition
	III	92	46	92	46	92	92	46	92	92	46	92	92	92	100	
	IV	46	46	46	46	46	92	46	92	92	92	92	92	92	100	
	V	46	46	46	46	46	46	92	46	92	92	92	92	92	100	
	VI	46	46	46	92	46	46	92	46	92	92	46	92	92	100	
	Hooks	50t hook(580kg)														

**Prerequisites:**

- ① Boom operating conditions(fully extended boom length),min.length is 13.25m and max.length is 60m
- ② The span of outriggers is 7.6m×7.6m
- ③ 360°rotation is applied
- ④ Counterweight is 23.5T,counterweight cylinder extend 860mm

Range ( m )	Main boom															Range ( m )	
	13.25	17.5	17.5	17.5	21.8	21.8	21.8	26.1	26.1	26.1	30.5	30.5	30.5	34.8	34.8		
3	100	91	86	62												3	
3.5	100	87	86	62												3.5	
4	97	85	82	62	80.5	78.4	57.5	65	58	55.7						4	
4.5	89	81	74	60	74.7	74.4	54.7	64	56	52.2	53	52	49			4.5	
5	83	72.5	71	59	69	68	51.8	63	53.6	48.7	52	50.2	48.5	43.3	41.3	5	
6	72	67	65	57	62	61	46.6	60	47.9	43.5	49.5	44	44.2	38.9	37.5	6	
7	59	60	59	56	55	55	42.2	57.4	43.6	39.3	47.1	39.4	40	34.6	33.8	7	
8	52.5	51	50	50	50.6	50	39.1	51.7	40.2	35.7	42.6	35.3	36.2	31.1	30.9	8	
9	44.5	44	43	42	46	45.6	36.1	47	37.3	32.8	38.9	32	33.2	28.2	28.1	9	
10	38.5	38.5	38	37	38.2	37.6	33.5	40.5	34.2	30.3	35.4	29.5	30.6	25.4	25.9	10	
12		29.5	30.2	30.9	28.5	29.1	29	29.3	29.3	26.2	30.2	25.2	26.7	21.9	22.4	12	
14		21.9	22.6	23.2	21.7	22.4	24.8	21.9	22.7	23.2	22.8	21.6	23.5	18.8	19.6	14	
16					16.7	17.4	19.6	17.1	17.5	19.4	17.9	17.2	19.3	16.4	17.4	16	
18					13.1	13.8	15.9	13.6	14.1	15.8	14.4	13.8	15.6	14.1	15.2	18	
20								11.3	11.8	13.4	11.8	11.2	13	11.5	12.5	20	
22								9.27	9.68	11.3	10.09	9.47	11.22	9.5	10.5	22	
24											8.34	7.82	9.57	7.9	8.9	24	
26											7	6.38	8.24	6.79	7.72	26	
28														5.66	6.59	28	
30														4.63	5.66	30	
32																32	
34																34	
36																36	
38																38	
40																40	
42																42	
44																44	
46																46	
48																48	
Number of lines	12	11	11	11	9	9	9	8	8	8	7	7	7	5	5	Number of lines	
Telescopic condition	II	0	46	0	0	46	0	0	46	92	0	46	92	0	92	46	II
	III	0	0	0	0	46	46	0	46	46	0	46	46	46	46	46	III
	IV	0	0	46	0	0	46	0	46	0	46	46	46	46	46	46	IV
	V	0	0	0	46	0	0	46	0	0	46	46	0	46	46	46	V
	VI	0	0	0	0	0	0	46	0	0	46	0	0	46	0	46	VI
	Hooks	110t hook(1815kg)										50t hook(580kg)					Hooks

**Prerequisites:**

- ① Boom operating conditions(fully extended boom length),min.length is 13.25m and max.length is 60m
- ② The span of outriggers is 7.6m×7.6m
- ③ 360°rotation is applied
- ④ Counterweight is 23.5T,counterweight cylinder extend 860mm

Range ( m )	Main boom															Range ( m )
	34.8	39	39	39	43.3	43.3	43.3	47.6	47.6	47.6	52	52	56.2	60		
3																3
3.5																3.5
4																4
4.5																4.5
5	38.8															5
6	35.5	33.2	32.8	31.1												6
7	32.2	30.3	29.9	28.9	25	23.5	22.2									7
8	28.9	27.5	27	26.7	24	22.6	21	21.5	20.5	18.3						8
9	26.5	25	24.5	24.5	23.4	21.8	20.8	20.5	19.6	17.4	17.7	15.4				9
10	24.3	23.2	22.6	22.6	22.5	20.6	19.5	19	18.7	16.5	17	14.8	13.1	11.4		10
12	21.2	19.6	19.4	19.7	20.1	19.5	17.4	18	16.9	14.7	15.7	13.5	12.4	10.8		12
14	18.4	17.1	16.8	17.2	17.6	17.8	15.5	17	15.4	13.1	14.3	12.3	11.6	10.2		14
16	16.3	14.8	14.8	15.4	15.8	15.9	14	15.8	13.8	11.8	13.2	11.3	10.9	9.6		16
18	14.6	13.2	13.1	13.8	14.6	14.1	12.6	14.6	12.5	10.7	12	10.4	10.1	9		18
20	12.9	11.8	11.8	12.4	12.2	12.7	11.4	12.4	11.4	9.7	11.2	9.6	9.5	8.3		20
22	10.8	10.5	10.5	11.1	10.2	10.6	10.4	10.4	10.3	8.9	10.2	8.8	8.8	7.8		22
24	9.2	8.6	8.8	9.4	8.5	9	9.5	8.7	9.3	8.2	9	8.2	8.1	7.3		24
26	8.01	7.2	7.5	8.1	7.2	7.7	8.4	7.4	8	7.5	7.7	7.6	7.7	6.8		26
28	6.9	6.1	6.4	7	6.1	6.6	7.3	6.3	6.9	6.9	6.6	7.1	7	6.4		28
30	5.97	5.35	5.66	6	5.2	5.6	6.3	5.4	5.9	6.4	5.7	6.3	6	6		30
32		4.53	4.84	5.35	4.7	4.8	5.5	4.6	5.1	5.6	4.9	5.5	5.2	5.3		32
34		3.81	4.12	4.63	3.81	4.1	4.94	3.9	4.4	4.9	4.2	4.8	4.5	4.6		34
36					3.19	3.5	4.32	3.3	3.8	4.3	3.6	4.2	3.9	4		36
38								2.78	3.39	3.8	3	3.6	3.4	3.4		38
40								2.36	2.88	3.3	2.6	3.2	2.9	2.9		40
42											2.16	2.78	2.5	2.5		42
44											1.75	2.47	2.1	2.1		44
46													1.75	1.85		46
48													1.44	1.54		48
Number of lines	5	4	4	4	3	3	3	3	3	3	2	2	2	2	Number of lines	
Telescopic condition	II	0	92	46	46	92	46	46	92	46	46	92	46	92	100	II
	III	92	46	92	46	92	92	46	92	92	46	92	92	92	100	III
	IV	46	46	46	46	46	92	46	92	92	92	92	92	92	100	IV
	V	46	46	46	46	46	46	92	46	92	92	92	92	92	100	V
	VI	46	46	46	92	46	46	92	46	92	46	92	92	92	100	VI
	Hooks	50t hook(580kg)										Hooks				

**Prerequisites:**

- ① Boom operating conditions(fully extended boom length),min.length is 13.25m and max.length is 60m
- ② The span of outriggers is 7.6m×7.6m
- ③ 360°rotation is applied
- ④ Counterweight is 23.5T,counterweight cylinder extend 860mm

Range ( m )	Main boom															Range ( m )		
	13.25	17.5	17.5	17.5	21.8	21.8	21.8	26.1	26.1	26.1	30.5	30.5	30.5	34.8	34.8			
3	100.00	91.00	86.00	82.00												3		
3.5	100.00	87.00	86.00	82.00												3.5		
4	97.00	85.00	82.00	82.00	80.50	78.40	57.50	65.00	58.00	55.70						4		
4.5	89.00	81.00	74.00	60.00	74.70	74.40	54.70	64.00	56.00	52.20	53.00	52.00	49.00			4.5		
5	83.00	72.50	71.00	59.00	69.00	68.00	51.80	63.00	53.60	48.70	52.00	50.20	48.50	43.30	41.30	5		
6	72.00	67.00	65.00	57.00	62.00	61.00	46.60	60.00	47.90	43.50	49.50	44.00	44.20	38.90	37.50	6		
7	59.00	60.00	59.00	56.00	55.00	55.00	42.20	57.40	43.60	39.30	47.10	39.40	40.00	34.60	33.80	7		
8	55.90	51.00	50.00	50.00	50.60	50.00	39.10	51.70	40.20	35.70	42.60	35.30	36.20	31.10	30.90	8		
9	47.31	44.00	43.00	42.00	46.00	45.60	36.10	47.00	37.30	32.80	38.90	32.00	33.20	28.20	28.10	9		
10	40.90	38.50	38.00	37.00	38.20	37.60	33.50	42.90	34.20	30.30	35.40	29.50	30.60	25.40	25.90	10		
12		31.35	32.05	32.75	30.35	30.95	29.00	31.15	29.30	26.20	32.05	25.20	26.70	21.90	22.40	12		
14		23.40	24.10	24.70	23.20	23.90	26.30	23.40	24.20	23.20	24.30	21.60	23.50	18.80	19.60	14		
16					17.97	18.67	20.87	18.37	18.77	20.67	19.17	18.47	20.57	16.40	17.40	16		
18					14.20	14.90	17.00	14.70	15.20	16.90	15.50	14.90	16.70	15.20	16.30	18		
20								12.27	12.77	14.37	12.77	12.17	13.97	12.47	13.47	20		
22								10.13	10.54	12.16	10.95	10.33	12.08	10.36	11.36	22		
24											9.12	8.60	10.35	8.68	9.68	24		
26											7.71	7.09	8.95	7.50	8.43	26		
28														6.31	7.24	28		
30														5.23	6.26	30		
32																32		
34																34		
36																36		
38																38		
40																40		
42																42		
44																44		
46																46		
48																48		
Number of lines	12	11	11	11	9	9	9	8	8	8	7	7	7	5	5	Number of lines		
Telescopic condition	II	0	46	0	0	46	0	0	46	92	0	46	92	0	92	46	II	Telescopic condition
	III	0	0	0	0	46	46	0	46	46	0	46	46	46	46	46	III	
	IV	0	0	46	0	0	46	0	46	0	46	46	46	46	46	46	IV	
	V	0	0	0	46	0	0	46	0	0	46	46	0	46	46	46	V	
	VI	0	0	0	0	0	0	46	0	0	46	0	0	46	0	46	VI	
	Hooks	110t hook(1815kg)										50t hook(580kg)					Hooks	

**Prerequisites:**

- ① Boom operating conditions(fully extended boom length),min.length is 13.25m and max.length is 60m
- ② The span of outriggers is 7.6m×7.6m
- ③ 360°rotation is applied
- ④ Counterweight is 23.5T,counterweight cylinder extend 860mm

Range ( m )	Main boom															Range ( m )	
	34.8	39	39	39	43.3	43.3	43.3	47.6	47.6	47.6	52	52	56.2	60			
3																3	
3.5																3.5	
4																4	
4.5																4.5	
5	38.80															5	
6	35.50	33.20	32.80	31.10												6	
7	32.20	30.30	29.90	28.90	25.00	23.50	22.20									7	
8	28.90	27.50	27.00	26.70	24.00	22.60	21.00	21.50	20.50	18.30						8	
9	26.50	25.00	24.50	24.50	23.40	21.80	20.80	20.50	19.60	17.40	17.70	15.40				9	
10	24.30	23.20	22.60	22.60	22.50	20.60	19.50	19.00	18.70	16.50	17.00	14.80	13.10	11.40		10	
12	21.20	19.60	19.40	19.70	20.10	19.50	17.40	18.00	16.90	14.70	15.70	13.50	12.40	10.80		12	
14	18.40	17.10	16.80	17.20	17.60	17.80	15.50	17.00	15.40	13.10	14.30	12.30	11.60	10.20		14	
16	16.30	14.80	14.80	15.40	15.80	15.90	14.00	15.80	13.80	11.80	13.20	11.30	10.90	9.60		16	
18	14.60	13.20	13.10	13.80	14.60	14.10	12.60	14.60	12.50	10.70	12.00	10.40	10.10	9.00		18	
20	13.87	11.80	11.80	12.40	13.17	13.67	11.40	13.37	11.40	9.70	11.20	9.60	9.50	8.30		20	
22	11.66	10.50	11.36	11.96	11.06	11.46	10.40	11.26	10.30	8.90	10.20	8.80	8.80	7.80		22	
24	9.98	9.38	9.58	10.18	9.28	9.78	9.50	9.48	10.08	8.20	9.28	8.20	8.10	7.30		24	
26	8.72	7.91	8.21	8.81	7.91	8.41	9.11	8.11	8.71	7.50	7.96	7.60	7.70	6.80		26	
28	7.55	6.75	7.05	7.65	6.75	7.25	7.95	6.95	7.55	6.90	6.84	7.10	7.65	6.40		28	
30	6.57	5.95	6.26	6.60	5.80	6.20	6.90	6.00	6.50	7.00	6.30	6.90	6.60	6.00		30	
32		5.09	5.40	5.91	5.26	5.36	6.06	5.16	5.66	6.16	5.46	6.06	5.76	5.86		32	
34		4.34	4.65	5.16	4.34	4.63	5.47	4.43	4.93	5.43	4.73	5.33	5.03	5.13		34	
36					3.68	3.99	4.81	3.79	4.29	4.79	4.09	4.69	4.39	4.49		36	
38								3.25	3.86	4.27	3.47	4.07	3.87	3.87		38	
40								2.80	3.04	3.74	3.04	3.64	3.34	3.34		40	
42											2.58	3.20	2.92	2.92		42	
44											2.15	2.87	2.50	2.50		44	
46												2.13	2.23			46	
48													1.57	1.90		48	
Number of lines	5	4	4	4	3	3	3	3	3	3	2	2	2	2	Number of lines		
Telescopic condition	II	0	92	46	46	92	46	46	92	46	46	92	46	92	100	II	Telescopic condition
	III	92	46	92	46	92	92	46	92	92	46	92	92	92	100	III	
	IV	46	46	46	46	46	92	46	92	92	92	92	92	92	100	IV	
	V	46	46	46	46	46	46	92	46	92	92	92	92	92	100	V	
	VI	46	46	46	92	46	46	92	46	92	46	92	92	92	100	VI	
	Hooks	50t hook(580kg)										Hooks					



**Prerequisites:**

- ① Boom operating conditions(fully extended boom length),min.length is 13.25m and max.length is 60m
- ② The span of outriggers is 7.6m×7.6m
- ③ 360°rotation is applied
- ④ Counterweight is 32.5T,counterweight cylinder extend 860mm

Range ( m )	Main boom															Range ( m )		
	13.25	17.5	17.5	17.5	21.8	21.8	21.8	26.1	26.1	26.1	30.5	30.5	30.5	34.8	34.8			
3	100	91	86	62												3		
3.5	100	87	86	62												3.5		
4	97	85	82	62	80.5	78.4	57.5	65	58	55.7						4		
4.5	89	81	74	60	74.7	74.4	54.7	64	56	52.2						4.5		
5	83	72.5	71	59	69	68	51.8	63	53.6	48.7	52	50.2	48.5	43.3	41.3	5		
5.5	77.5	69.75	68	58	65.5	64.5	49.2	61.5	50.75	46.1	50.8	47.1	46.4	41.1	39.4	5.5		
6	72	67	65	57	62	61	46.6	60	47.9	43.5	49.5	44	44.2	38.9	37.5	6		
6.5	65.5	63.5	62	56.5	58.5	58	44.4	58.7	45.75	41.4	48.3	41.7	42.1	36.75	35.65	6.5		
7	59	60	59	56	55	55	42.2	57.4	43.6	39.3	47.1	39.4	40	34.6	33.8	7		
8	53	51	50	50	50.6	50	39.1	51.7	40.2	35.7	42.6	35.3	36.2	31.1	30.9	8		
9	45	44	43	42	46	45.6	36.1	47	37.3	32.8	38.9	32	33.2	28.2	28.1	9		
10	39	38.5	38	37	38.2	37.6	33.5	43.5	34.2	30.3	35.4	29.5	30.6	25.4	25.9	10		
11		35.85	35	34	35.1	34.3	31.25	39	31.75	28.25	32.95	27.35	28.65	23.65	24.15	11		
12		33.2	32	31	32	31	29	34.5	29.3	26.2	30.5	25.2	26.7	21.9	22.4	12		
14		25.2	26.8	27.3	24	24	26.471	26.7	25.6	23.2	26.6	21.6	23.5	18.8	19.6	14		
16					20	20.9	23.793	21	21.6	20.5	21.8	19.1	20.9	16.4	17.4	16		
18					16.5	16.8	19.57	16.9	17.5	18.8	17.6	16.8	18.9	14.4	15.6	18		
20								13.8	14.4	16.1	14.5	13.8	16	12.6	13.5	20		
22								11.4	12	13.7	12.463	11.742	13.6	11.3	11.3	22		
24											10.506	9.785	11.7	9.7	9.6	24		
26											9.27	8.137	10.1	8.343	8.2	26		
28														7.004	7.1	28		
30														5.871	6.1	30		
32																32		
34																34		
36																36		
38																38		
40																40		
42																42		
44																44		
46																46		
48																48		
50																50		
52																52		
Number of lines	12	11	11	11	9	9	9	8	8	8	6	6	6	5	5	Number of lines		
Telescopic condition	II	0	46	0	0	46	0	0	46	92	0	46	92	0	92	46	II	Telescopic condition
	III	0	0	0	0	46	46	0	46	46	0	46	46	46	46	46	III	
	IV	0	0	46	0	0	46	0	46	0	46	46	46	46	46	46	IV	
	V	0	0	0	46	0	0	46	0	0	46	46	0	46	46	46	V	
	VI	0	0	0	0	0	0	46	0	0	46	0	0	46	0	46	VI	
	Hooks	110t hook(1815kg)										50t hook(580kg)					Hooks	

**Prerequisites:**

- ① Boom operating conditions(fully extended boom length),min.length is 13.25m and max.length is 60m
- ② The span of outriggers is 7.6m×7.6m
- ③ 360°rotation is applied
- ④ Counterweight is 32.5T,counterweight cylinder extend 860mm

Range ( m )	Main boom															Range ( m )	
	34.8	39	39	39	43.3	43.3	43.3	47.6	47.6	47.6	52	52	56.2	60			
3																3	
3.5																3.5	
4																4	
4.5																4.5	
5	38.8															5	
5.5	37.15															5.5	
6	35.5	33.2	32.8	31.1												6	
6.5	33.85	31.75	31.35	30												6.5	
7	32.2	30.3	29.9	28.9	25	23.5	22.2									7	
8	28.9	27.5	27	26.7	24	22.6	21	21.5	20.5	18.3						8	
9	26.5	25	24.5	24.5	23.4	21.8	20.8	20.5	19.6	17.4	17.7	15.4				9	
10	24.3	23.2	22.6	22.6	22.5	20.6	19.5	19	18.7	16.5	17	14.8	13.1	11.4		10	
11	22.75	21.4	21	21.15	21.3	20.05	18.45	18.5		15.6	16.35	14.15	12.75	11.1		11	
12	21.2	19.6	19.4	19.7	20.1	19.5	17.4	18	16.9	14.7	15.7	13.5	12.4	10.8		12	
14	18.4	17.1	16.8	17.2	17.6	17.8	15.5	17	15.4	13.1	14.3	12.3	11.6	10.2		14	
16	16.3	14.8	14.8	15.4	15.8	15.9	14	15.8	13.8	11.8	13.2	11.3	10.9	9.6		16	
18	14.6	13.2	13.1	13.8	14.6	14.1	12.6	14.6	12.5	10.7	12	10.4	10.1	9		18	
20	13	11.8	11.8	12.4	13.8	12.9	11.4	13.2	11.4	9.7	11.2	9.6	9.5	8.3		20	
22	11.8	10.5	10.6	11.3	12.4	11.8	10.4	12.2	10.3	8.9	10.2	8.8	8.8	7.8		22	
24	10.7	9.5	9.5	10.3	10.6	10.8	9.5	11.1	9.5	8.2	9.4	8.2	8.1	7.3		24	
26	10	8.6	8.7	9.5	9.1	9.7	8.8	9.6	8.7	7.5	8.6	7.6	7.7	6.8		26	
28	8.755	7.5	7.9	8.6	7.9	8.6	8.1	8.3	7.9	6.9	8	7.1	7.1	6.4		28	
30	7.519	6.592	6.8	7.725	6.8	7.5	7.5	7.2	7.3	6.5	7.5	6.5	6.7	6		30	
32		5.665	5.8	6.695	6	6.5	7.1	6.3	6.8	5.9	6.6	6	6.2	5.6		32	
34		4.738	5	5.871	5.1	5.7	6.4	5.5	6	5.6	5.8	5.6	5.8	5.2		34	
36					4.5	5	5.7	4.8	5.3	5.3	5.1	5.2	5.4	4.8		36	
38								4.1	4.7	4.9	4.4	4.8	4.8	4.5		38	
40								3.6	4.1	4.6	3.9	4.5	4.2	4.2		40	
42											3.4	4	3.7	3.8		42	
44											2.9	3.605	3.3	3.3		44	
46												2.9	2.9			46	
48													2.5	2.6		48	
50														2.2		50	
52														1.9		52	
Number of lines	5	4	4	4	3	3	3	3	3	3	2	2	2	2	Number of lines		
Telescopic condition	II	0	92	46	46	92	46	46	92	46	46	92	46	92	100	II	Telescopic condition
	III	92	46	92	46	92	92	46	92	92	46	92	92	92	100	III	
	IV	46	46	46	46	46	92	46	92	92	92	92	92	92	100	IV	
	V	46	46	46	46	46	46	92	46	92	92	92	92	92	100	V	
	VI	46	46	46	92	46	46	92	46	92	46	92	92	92	100	VI	
	Hooks	50t hook(580kg)										Hooks					

**Prerequisites:**

- ① Boom operating conditions(fully extended boom length),min.length is 13.25m and max.length is 60m
- ② The span of outriggers is 7.6m×7.6m
- ③ 360°rotation is applied
- ④ Counterweight is 32.5T,counterweight cylinder extend 860mm

Range ( m )	Main boom															Range ( m )	
	13.25	17.5	17.5	17.5	21.8	21.8	21.8	26.1	26.1	26.1	30.5	30.5	30.5	34.8	34.8		
3	100.00	91.00	86.00	82.00												3	
3.5	100.00	87.00	86.00	82.00												3.5	
4	97.00	85.00	82.00	82.00	80.50	78.40	57.50	65.00	58.00	55.70						4	
4.5	89.00	81.00	74.00	60.00	74.70	74.40	54.70	64.00	56.00	52.20						4.5	
5	83.00	72.50	71.00	59.00	69.00	68.00	51.80	63.00	53.60	48.70	52.00	50.20	48.50	43.30	41.30	5	
5.5	77.50	69.75	68.00	58.00	65.50	64.50	49.20	61.50	50.75	46.10	50.80	47.10	46.40	41.10	39.40	5.5	
6	72.00	67.00	65.00	57.00	62.00	61.00	46.60	60.00	47.90	43.50	49.50	44.00	44.20	38.90	37.50	6	
6.5	65.50	63.50	62.00	56.50	58.50	58.00	44.40	58.70	45.75	41.40	48.30	41.70	42.10	36.75	35.65	6.5	
7	59.00	60.00	59.00	56.00	55.00	55.00	42.20	57.40	43.60	39.30	47.10	39.40	40.00	34.60	33.80	7	
8	53.00	51.00	50.00	50.00	50.60	50.00	39.10	51.70	40.20	35.70	42.60	35.30	36.20	31.10	30.90	8	
9	45.00	44.00	43.00	42.00	46.00	45.60	36.10	47.00	37.30	32.80	38.90	32.00	33.20	28.20	28.10	9	
10	42.31	41.81	38.00	37.00	38.20	37.60	33.50	43.50	34.20	30.30	35.40	29.50	30.60	25.40	25.90	10	
11		38.74	37.89	34.00	37.99	34.30	31.25	39.00	31.75	28.25	32.95	27.35	28.65	23.65	24.15	11	
12		35.76	34.56	31.00	34.56	31.00	29.00	34.50	29.30	26.20	30.50	25.20	26.70	21.90	22.40	12	
14		27.28	28.88	29.38	26.08	26.08	26.47	26.70	27.68	23.20	26.60	21.60	23.50	18.80	19.60	14	
16					21.75	22.65	23.79	22.75	23.35	20.50	21.80	19.10	20.90	16.40	17.40	16	
18					18.02	18.32	21.09	18.42	19.02	20.32	19.12	18.32	18.90	14.40	15.60	18	
20								15.13	15.73	17.43	15.83	15.13	17.33	12.60	13.50	20	
22								12.59	13.19	14.89	13.66	12.93	14.79	12.49	11.30	22	
24											11.58	10.86	12.78	10.78	9.60	24	
26											10.25	9.12	11.08	9.33	9.18	26	
28														7.91	8.00	28	
30														6.71	6.94	30	
32																32	
34																34	
36																36	
38																38	
40																40	
42																42	
44																44	
46																46	
48																48	
50																50	
52																52	
Number of lines	12	11	11	11	9	9	9	8	8	8	6	6	6	5	5	Number of lines	
Telescopic condition	II	0	46	0	0	46	0	0	46	92	0	46	92	0	92	46	II
	III	0	0	0	0	46	46	0	46	46	0	46	46	46	46	46	III
	IV	0	0	46	0	0	46	0	46	0	46	46	46	46	46	46	IV
	V	0	0	0	46	0	0	46	0	0	46	46	0	46	46	46	V
	VI	0	0	0	0	0	0	46	0	0	46	0	0	46	0	46	VI
	Hooks	110t hook(1815kg)										50t hook(580kg)					Hooks

**Prerequisites:**

- ① Boom operating conditions(fully extended boom length),min.length is 13.25m and max.length is 60m
- ② The span of outriggers is 7.6m×7.6m
- ③ 360°rotation is applied
- ④ Counterweight is 32.5T,counterweight cylinder extend 860mm



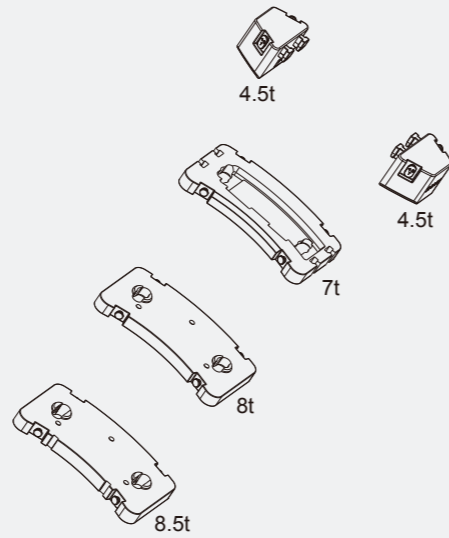
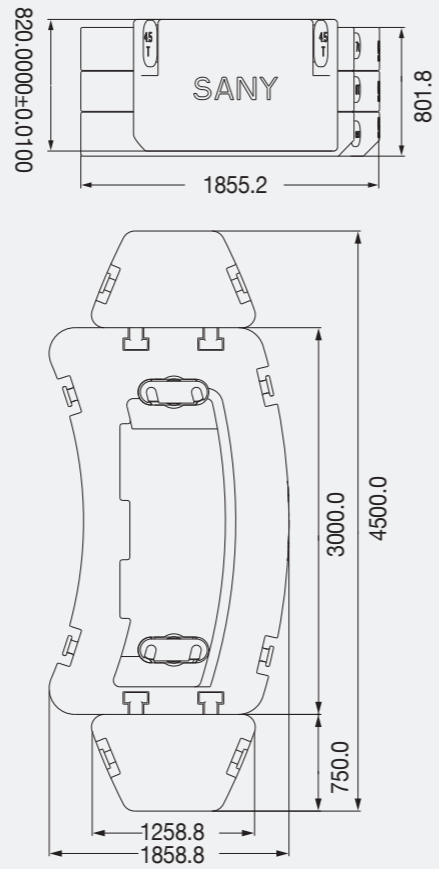
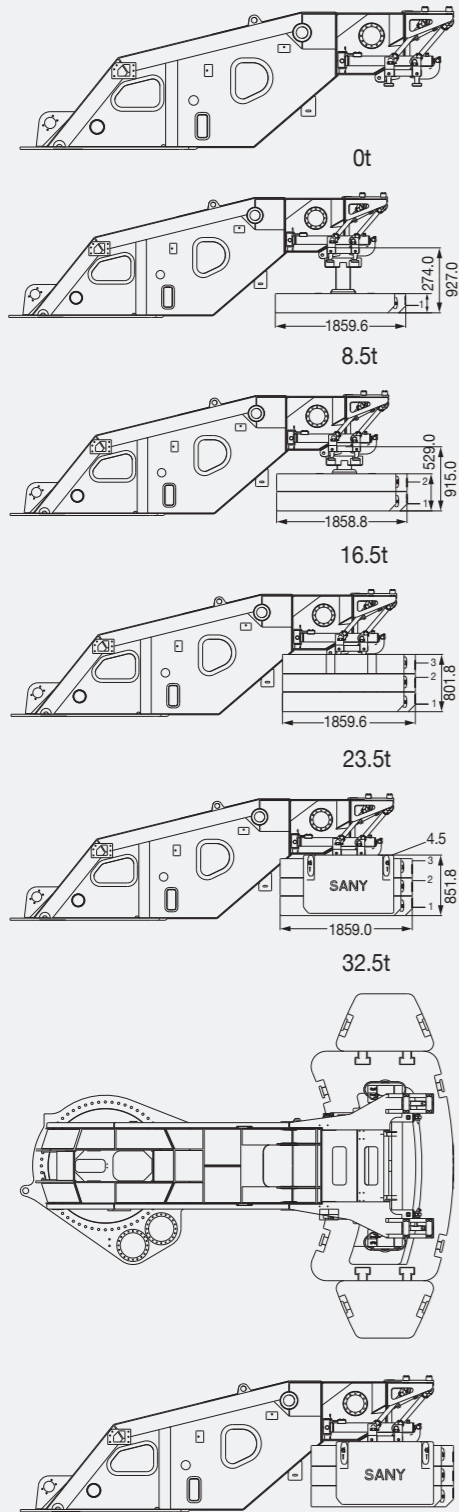

Range ( m )	Main boom															Range ( m )
	34.8	39	39	39	43.3	43.3	43.3	47.6	47.6	47.6	52	52	56.2	60		
3																3
3.5																3.5
4																4
4.5																4.5
5	38.80															5
5.5	37.15															5.5
6	35.50	33.20	32.80	31.10												6
6.5	33.85	31.75	31.35	30.00												6.5
7	32.20	30.30	29.90	28.90	25.00	23.50	22.20									7
8	28.90	27.50	27.00	26.70	24.00	22.60	21.00	21.50	20.50	18.30						8
9	26.50	25.00	24.50	24.50	23.40	21.80	20.80	20.50	19.60	17.40	17.70	15.40				9
10	24.30	23.20	22.60	22.60	22.50	20.60	19.50	19.00	18.70	16.50	17.00	14.80	13.10	11.40		10
11	22.75	21.40	21.00	21.15	21.30	20.05	18.45	18.50		15.60	16.35	14.15	12.75	11.10		11
12	21.20	19.60	19.40	19.70	20.10	19.50	17.40	18.00	16.90	14.70	15.70	13.50	12.40	10.80		12
14	18.40	17.10	16.80	17.20	17.60	17.80	15.50	17.00	15.40	13.10	14.30	12.30	11.60	10.20		14
16	16.30	14.80	14.80	15.40	15.80	15.90	14.00	15.80	13.80	11.80	13.20	11.30	10.90	9.60		16
18	14.60	13.20	13.10	13.80	14.60	14.10	12.60	14.60	12.50	10.70	12.00	10.40	10.10	9.00		18
20	13.00	11.80	11.80	12.40	13.80	12.90	11.40	13.20	11.40	9.70	11.20	9.60	9.50	8.30		20
22	12.99	10.50	10.60	11.30	12.40	11.80	10.40	12.20	10.30	8.90	10.20	8.80	8.80	7.80		22
24	11.78	9.50	9.50	10.30	10.60	10.80	9.50	11.10	9.50	8.20	9.40	8.20	8.10	7.30		24
26	10.98	9.58	8.70	9.50	9.10	10.68	8.80	9.60	8.70	7.50	8.60	7.60	7.70	6.80		26
28	9.66	8.40	7.90	8.60	7.90	9.50	8.10	8.30	7.90	6.90	8.00	7.10	7.10	6.40		28
30	8.35	7.43	7.64	7.73	7.64	8.34	8.34	8.04	7.30	6.50	7.50	6.50	6.70	6.00		30
32		6.44	6.58	7.47	6.78	7.28	7.88	7.08	6.80	6.68	6.60	6.00	6.20	5.60		32
34		5.47	5.73	6.60	5.83	6.43	7.13	6.23	6.00	6.33	5.80	5.60	5.80	5.20		34
36					5.18	5.68	6.38	5.48	5.98	5.98	5.78	5.20	5.40	4.80		36
38								4.74	5.34	5.54	5.04	4.80	4.80	4.50		38
40								4.21	4.71	5.21	4.51	5.11	4.20	4.81		40
42											3.98	4.58	4.28	4.38		42
44											3.45	4.15	3.85	3.85		44
46												3.42	3.42			46
48												3.00	3.10			48
50													2.68			50
52													2.36			52
Number of lines	5	4	4	4	3	3	3	3	3	3	2	2	2	2	Number of lines	
Telescopic condition	II	0	92	46	46	92	46	46	92	46	46	92	46	92	100	II
	III	92	46	92	46	92	92	46	92	46	92	92	92	92	100	III
	IV	46	46	46	46	46	92	46	92	46	92	92	92	92	100	IV
	V	46	46	46	46	46	46	92	46	92	46	92	92	92	100	V
	VI	46	46	46	92	46	46	92	46	92	46	92	92	92	100	VI
	Hooks	50t hook(580kg)										Hooks				



TRUCK CRANE

 <b>STC200</b> Maximum Load Capacity: 20t Telescopic Boom: 4 Sections, 10.6-33m	 <b>STC250</b> Maximum Load Capacity: 25t Telescopic Boom: 4 Sections, 10.65-33.5m	 <b>STC250H</b> Maximum Load Capacity: 25t Telescopic Boom: 5 Sections, 10.5-39.5m	 <b>STC300TH</b> Maximum Load Capacity: 30t Telescopic Boom: 4 Sections, 10.6-33.5m
 <b>STC300H</b> Maximum Load Capacity: 30t Telescopic Boom: 5 Sections, 10.5-39.5m	 <b>STC500</b> Maximum Load Capacity: 50t Telescopic Boom: 5 Sections, 11.5-43m	 <b>STC550</b> Maximum Load Capacity: 55t Telescopic Boom: 5 Sections, 11.5-43m	 <b>STC550EYR</b> Maximum Load Capacity: 55t Telescopic Boom: 5 Sections, 11.5-43m
 <b>STC600</b> Maximum Load Capacity: 60t Telescopic Boom: 5 Sections, 11.5-43m	 <b>STC750</b> Maximum Load Capacity: 75t Telescopic Boom: 5 Sections, 11.8-45m	 <b>STC800</b> Maximum Load Capacity: 80t Telescopic Boom: 5 Sections, 11.8-45m	 <b>STC800EYR</b> Maximum Load Capacity: 80t Telescopic Boom: 5 Sections, 11.8-45m
 <b>STC1000</b> Maximum Load Capacity: 100t Telescopic Boom: 5 Sections, 13.5-52m	 <b>STC1000C</b> Maximum Load Capacity: 100t Telescopic Boom: 6 Sections, 13.25-60m	 <b>STC1300C</b> Maximum Load Capacity: 130t Telescopic Boom: 6 Sections, 13.3-60m	

ALL TERRAIN CRANE

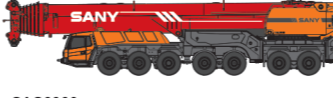
 <b>SAC1800</b> Maximum Load Capacity: 180t Telescopic Boom: 6 Sections, 13.5-62m	 <b>SAC2200</b> Maximum Load Capacity: 220t Telescopic Boom: 6 Sections, 13.5-62m	 <b>SAC3000</b> Maximum Load Capacity: 300t Telescopic Boom: 7 Sections, 15.4-80m	 <b>SAC3500</b> Maximum Load Capacity: 350t Telescopic Boom: 6 Sections, 15.2-70m
 <b>SAC6000</b> Maximum Load Capacity: 600t Telescopic Boom: 7 Sections, 17.1-90m			

ROUGH-TERRAIN CRANE

 <b>SRC350</b> Maximum Load Capacity: 35t Telescopic Boom: 4 Sections, 10-31.5m	 <b>SRC550</b> Maximum Load Capacity: 55t Telescopic Boom: 4 Sections, 11.25-34.5m	 <b>SRC550H</b> Maximum Load Capacity: 55t Telescopic Boom: 5 Sections, 11.5-42.5m	 <b>SRC750</b> Maximum Load Capacity: 75t Telescopic Boom: 5 Sections, 11.8-45m
---	--	--	---





Quality Changes the World

## SANY AUTOMOBILE HOISTING MACHINERY

Address: SANY Industrial Park, Jinzhou Development Zone,  
Changsha, Hunan, China.

Service Hotline: 4006098318

Email: [crd@sany.com.cn](mailto:crd@sany.com.cn)

For more information, please visit: [www.sanygroup.com](http://www.sanygroup.com)

For our consistent improvement in technology, specifications may change without notice.  
The machines illustrated may show optional equipment which can be supplied at additional cost.

Distributed By: شركة محمد عبدالله العريش المحدودة  
Mohammad Abdullah Al Areeedh Ltd. Co.

Ibn Alameed Str 11464  
Riyadh, Saudi Arabia

Tel: +966 9200 11 888

Fax: +966 11 241 2377

e-Mail: [info@alareedh.com](mailto:info@alareedh.com)

[www.alareedh.com](http://www.alareedh.com)

